



**Department of Energy**  
Richland Operations Office  
P.O. Box 550  
Richland, Washington 99352

98-WDD-048

**MAY 19 1998**

The Honorable John T. Conway  
Chairman  
Defense Nuclear Facilities Safety Board  
625 Indiana Avenue, N.W., Suite 700  
Washington, D.C. 20004

Dear Mr. Chairman:

DEFENSE NUCLEAR FACILITIES SAFETY BOARD (DNFSB) RECOMMENDATION 92-4 IMPLEMENTATION PLAN (IP), MILESTONES 5.2.1.a "DEVELOP A TECHNICAL REQUIREMENTS SPECIFICATION FOR THE SECOND AND FUTURE TANK RETRIEVAL SYSTEMS IN THE TANK WASTE REMEDIATION SYSTEMS (TWRS) INITIAL TANK RETRIEVAL SYSTEM PROJECT," AND 5.2.1.b "PROVIDE A BASELINE COMPARISON REPORT FOR THE FIRST TANK RETRIEVAL SYSTEM IN THE TWRS INITIAL TANK RETRIEVAL SYSTEM PROJECT"

As required by DNFSB Recommendation 92-4 IP, Revision 2N, Commitment 5.2.1.a, due December 31, 1998, and Commitment 5.2.1.b, due February 28, 1998, enclosed are the "System Specification for the Double-Shell Tank System," HNF-SD-WM-TRD-007, Revision D, dated April 1998, and the "Baseline Comparison of Double-Shell Tank System Specification to the W-211 Functional Design Criteria," dated April 1998. These documents were transmitted through the liaison office to DNFSB technical staff on April 17, 1998.

The documents are submitted to meet the requested extension due dates of May 31, 1998, and July 31, 1998, for the system specification and baseline comparison reports, respectively.

RL has completed the actions identified under these milestones, and proposes closure of these commitments.

If you have any questions, please contact me, or your staff may contact William J. Taylor, Waste Disposal Division, on (509) 372-3864.

Sincerely,

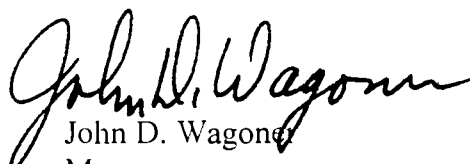
  
John D. Wagone  
Manager

WDD:JJD

Enclosures (2)

# System Specification for the Double-Shell Tank System

Prepared for the U.S. Department of Energy



**Fluor Daniel Hanford, Inc.**  
Richland, Washington

Hanford Management and Integration Contractor for the  
U.S. Department of Energy under Contract DE-AC06-96RL13200

## RELEASE AUTHORIZATION

Document Number: HNF-SD-WM-TRD-007, DRAFT D

Document Title: System Specification for the  
Double-Shell Tank System

This document, reviewed in accordance with DOE Order 1430.1D, "Scientific and Technical Information Management," and DOE G 1430.1D-1, "Guide to the Management of Scientific and Technical Information," does not contain classified or sensitive unclassified information and is:

**APPROVED FOR PUBLIC RELEASE**

*V. L. Birkland*  
\_\_\_\_\_  
V. L. Birkland

*4/2/98*  
\_\_\_\_\_

Lockheed Martin Services, Inc.  
Document Control/Information Clearance

Reviewed for Applied Technology, Business Sensitive, Classified, Copyrighted, Export Controlled, Patent, Personal/Private, Proprietary, Protected CRADA, Trademark, Unclassified Controlled Nuclear Information.

**LEGAL DISCLAIMER.** This report was prepared as an account of work sponsored by an agency of the United States Government. Neither the United States Government nor any agency thereof, nor any of their employees, nor any of their contractors, subcontractors or their employees, makes any warranty, express or implied, or assumes any legal liability or responsibility for the accuracy, completeness, or any third party's use or the results of such use of any information, apparatus, product, or process disclosed, or represents that its use would not infringe privately owned rights. Reference herein to any specific commercial product, process, or service by trade name, trademark, manufacturer, or otherwise, does not necessarily constitute or imply its endorsement, recommendation, or favoring by the United States Government or any agency thereof or its contractors or subcontractors. The views and opinions of authors expressed herein do not necessarily state or reflect those of the United States Government or any agency thereof. This report has been reproduced from the best available copy. Printed in the United States of America.

# System Specification for the Double-Shell Tank System

**C. E. Grenard**  
Cogema Engineering Corp.

**R. D. Claghorn**  
**R. P. Marshall, Jr.**  
Numatec Hanford Corporation

**M. A. deLamare**  
TRW Systems Integration Group

Date Published  
April 1998

Prepared for the U.S. Department of Energy



**Fluor Daniel Hanford, Inc.**  
P.O. Box 1000  
Richland, Washington

Hanford Management and Integration Contractor for the  
U.S. Department of Energy under Contract DE-AC06-96RL13200

This page intentionally left blank.

**CONTENTS**

1.0 SCOPE ..... 1

    1.1 IDENTIFICATION ..... 1

    1.2 DOUBLE-SHELL TANK SYSTEM SEGMENT OVERVIEW ..... 2

        1.2.1 Relationship to Hanford Site Missions ..... 2

        1.2.2 Double-Shell Tank System Purpose ..... 6

    1.3 DOCUMENT OVERVIEW ..... 6

2.0 APPLICABLE DOCUMENTS ..... 9

    2.1 GOVERNMENT SOURCES ..... 9

    2.2 NONGOVERNMENT DOCUMENTS ..... 10

3.0 DOUBLE-SHELL TANK WASTE RETRIEVAL SYSTEM  
FUNCTIONS AND REQUIREMENTS ..... 13

    3.1 SYSTEM DEFINITION ..... 13

        3.1.1 Functional Description—Double-Shell Tank System ..... 13

        3.1.2 System Description ..... 18

    3.2 SYSTEM CHARACTERISTICS ..... 21

        3.2.1 Performance Characteristics ..... 21

            3.2.1.1 Maintain Safe and Compliant Waste within the  
                    Double-Shell Tank System ..... 22

                3.2.1.1.1 Store Waste in West Area Double-Shell Tanks ..... 22

                3.2.1.1.2 Store Waste in East Area Double-Shell Tanks ..... 22

                3.2.1.1.3 Transfer Waste from 204-AR Waste Unloading Facility to  
                    East Area Double-Shell Tanks ..... 22

                3.2.1.1.4 Receive New Liquid Waste into West Area  
                    Double-Shell Tanks ..... 23

                3.2.1.1.5 Receive New Liquid Waste into East Area  
                    Double-Shell Tanks ..... 23

                3.2.1.1.6 Receive Concentrated Waste from Evaporator ..... 23

                3.2.1.1.7 Receive Emergency Purge from Evaporator ..... 23

                3.2.1.1.8 Receive Waste Products from Low-Activity Waste/  
                    High-Level Waste and Low-Activity Waste Treatment ..... 23

            3.2.1.2 Remove Waste from Double-Shell Tanks, Phase 1 ..... 24

                3.2.1.2.1 Prepare Waste in West Area Double-Shell Tanks ..... 25

                3.2.1.2.2 Transfer Waste Between West Area Double-Shell Tanks ..... 25

                3.2.1.2.3 Transfer Waste Cross-Site ..... 25

                3.2.1.2.4 Prepare Waste in East Area Double-Shell Tanks ..... 26

                3.2.1.2.5 Transfer Waste Between East Area Double-Shell Tanks ..... 26

                3.2.1.2.6 Transfer Waste for Concentration ..... 26

                3.2.1.2.7 Transfer Waste to Low-Activity Waste Staging Tanks ..... 27

            3.2.1.3 Prepare Low-Activity Waste Feed for Phase 1 Treatment ..... 27

**CONTENTS (Continued)**

3.2.1.3.1 Blend Low-Activity Waste in Low-Activity Waste Staging Tanks .....	29
3.2.1.3.2 Transfer Low-Activity Waste Supernatants to Vendor Feed Storage .....	29
3.2.1.4 Prepare High-Level Waste Feed for Phase 1 Treatment .....	30
3.2.1.4.1 Perform Enhanced Sludge Washing (In-tank) .....	30
3.2.1.4.2 Transfer Sludge Wash Supernatants to East Double-Shell Tanks .....	32
3.2.1.4.3 Prepare High-Level Waste Solids .....	33
3.2.1.4.4 Transfer High-Level Waste Sludge to Low-Activity Waste/High-Level Waste Plant .....	34
3.2.1.5 Sample Double-Shell Tank Waste .....	34
3.2.1.6 Distribute Utilities in Double-Shell Tank System .....	34
3.2.1.7 Support Double-Shell Tank System .....	35
3.2.2 Reserved .....	35
3.2.3 External Interface Requirements .....	35
3.2.3.1 External Waste Generators Using Surface Transport .....	35
3.2.3.2 Plutonium Finishing Plant (PFP) .....	35
3.2.3.3 S Plant .....	36
3.2.3.4 B Plant/Waste Encapsulation and Storage Facility (WESF) .....	36
3.2.3.5 Single-Shell Tank System .....	36
3.2.3.6 Evaporator .....	37
3.2.3.7 Phase 1 Low-Activity Waste Plant .....	37
3.2.3.8 Phase 1 Low-Activity Waste/High-Level Waste Plant .....	40
3.2.3.9 Central Plateau Electrical System .....	40
3.2.3.10 Central Plateau Water System .....	40
3.2.4 Physical Characteristics .....	41
3.2.5 System Quality Factors .....	41
3.2.5.1 Reliability, Availability, Maintainability .....	41
3.2.5.2 Additional Quality Factors .....	41
3.2.5.2.1 Design Life .....	41
3.2.6 Environmental Conditions .....	41
3.2.6.1 Environmental Conditions .....	41
3.2.6.2 Chemical .....	41
3.2.6.3 Radiation .....	41
3.2.7 Transportability .....	42
3.2.8 Flexibility and Expansion .....	42
3.2.9 Portability .....	42
3.3 DESIGN AND CONSTRUCTION .....	42
3.3.1 Materials, Processes, and Design Practices .....	42
3.3.1.1 Toxic Products and Formulations .....	42

## CONTENTS (Continued)

3.3.1.2	Dangerous Waste .....	42
3.3.1.3	Decontamination and Decommissioning .....	42
3.3.2	Electromagnetic Radiation .....	42
3.3.3	Nameplates and Product Markings .....	43
3.3.4	Workmanship .....	43
3.3.5	Interchangeability .....	43
3.3.6	Safety .....	43
3.3.6.1	Personnel Safety .....	43
3.3.6.1.1	Occupational Radiological Protection .....	43
3.3.6.1.2	Occupational Safety and Health Administration (OSHA) Standards .....	43
3.3.6.2	System Safety .....	43
3.3.6.2.1	Corrosion Prevention and Control .....	43
3.3.6.2.2	Waste Composition .....	44
3.3.6.2.3	Tank Temperature Limits .....	44
3.3.6.2.4	Dome Vault Loading .....	44
3.3.6.3	Environmental Safety .....	44
3.3.6.3.1	Secondary Containment and Leak Detection .....	44
3.3.6.3.2	Spill Prevention and Controls .....	44
3.3.6.3.3	Nonradioactive Airborne Emissions .....	44
3.3.6.3.4	Radioactive Airborne Emissions .....	45
3.3.6.3.5	Monitoring of Liquid Effluent Discharges to the Environment ...	45
3.3.6.3.6	Radiation Protection of the Public and Environment .....	45
3.3.6.3.7	Flammable Gas Design Requirements .....	45
3.3.7	Human Engineering .....	45
3.3.8	Nuclear Safety .....	45
3.3.8.1	Criticality Safety .....	45
3.3.8.2	Nuclear Safety Classification .....	45
3.3.9	System Security .....	45
3.3.9.1	General System and Information Security .....	45
3.3.9.2	Radiation Area Security .....	46
3.3.10	Government-Furnished Property Usage .....	46
3.3.11	Computer Resource Reserve Capacity .....	46
3.4	DOCUMENTATION .....	46
3.5	LOGISTICS .....	46
3.5.1	Maintenance and Operation .....	46
3.5.1.1	Calibration .....	46
3.5.2	Transportation of Hazardous Materials .....	46
3.5.3	Solid Waste .....	47
3.5.3.1	Solid Waste Acceptance Criteria .....	47
3.6	PERSONNEL AND TRAINING .....	47



**CONTENTS (Continued)**

3.7	CHARACTERISTICS OF SUBELEMENTS .....	47
3.7.1	Double-Shell Tank Farms .....	47
3.7.2	Transfer System .....	47
3.7.3	Waste Preparation Equipment .....	47
3.7.4	Double-Shell Tank Master Monitor and Control System .....	48
3.7.5	Double-Shell Tank Utility Distribution System .....	48
3.7.6	Double-Shell Tank Maintenance and Recovery Systems .....	48
3.8	PRECEDENCE .....	48
3.9	QUALIFICATION .....	48
3.10	STANDARD SAMPLE .....	49
3.11	PREPRODUCTION STANDARD .....	49
4.0	QUALITY ASSURANCE PROVISIONS .....	51
4.1	RESPONSIBILITY FOR INSPECTIONS .....	51
4.2	SPECIAL TESTS AND EXAMINATIONS .....	51
4.3	QUALITY CONFORMANCE INSPECTIONS .....	51
5.0	PREPARATION FOR DELIVERY .....	61
6.0	NOTES .....	63
6.1	INTENDED USE .....	63
6.1.1	Missions .....	63
6.1.2	Special Hazards .....	63
6.1.2.1	High Radiation Levels .....	63
6.2	ASSUMPTIONS .....	63
6.3	ACRONYMS .....	64
6.4	DEFINITIONS .....	65
6.5	REFERENCES .....	65
7.0	LIST OF APPENDICES .....	73
APPENDIX		
A	REQUIREMENT TRACEABILITY .....	A-1

**LIST OF FIGURES**

1-1	Hanford Site Technical Baseline Major Facilities Allocated to Tank Waste Remediation System .....	3
1-2	Tank Waste Remediation System Operation and Maintenance Scenario Flow Diagram .	4
1-3	Functions Allocated to Tank Waste Remediation System Architectures .....	5
3-1	Level 4 Double-Shell Tank System Operations and Maintenance Flow. ....	14
3-2	Double-Shell Tank System Functional Flow Block Diagram .....	15
3-3	Double-Shell Tank System Interface Diagram .....	19
3-4	Phase 1 Double-Shell Tank System .....	20

**LIST OF TABLES**

3-1	Phase 1, Double-Shell Tank System Functions .....	13
3-2	Double-Shell Tank, Existing System Items .....	18
3-3	Low-Activity Waste Chemical Composition .....	28
3-4	Low-Activity Waste Radionuclide Composition .....	29
3-5	Minimum and Maximum Order Quantities .....	29
3-6	High-Level Waste Feed Composition Limits for Nonvolatile Components .....	31
3-7	High-Level Waste Feed Composition Limits for Volatile Components .....	32
3-8	Maximum Radionuclide Composition of High-Level Waste Feed .....	33
3-9	High-Level Waste Feed Physical Properties .....	34
3-10	204-AR Vault Waste Composition Requirements for Receipt .....	35
3-11	Maximum Radionuclide Concentrations after Evaporation .....	38
3-12	Physical Requirements for Liquids or Slurries Transferred to U.S. Department of Energy .....	39
3-13	Double-Shell Tank Waste Storage Composition Requirements .....	44
4-1	Double-Shell Tank System Quality Conformance Inspection Matrix .....	53

## SYSTEM SPECIFICATION FOR THE DOUBLE-SHELL TANK SYSTEM

### 1.0 SCOPE

#### 1.1 IDENTIFICATION

This specification establishes the functional, performance, design, development, interface, and test requirements for the Double-Shell Tank (DST) System segment, hereafter referred to as the system or the DST System, of the Tank Waste Remediation System (TWRS) located at the Hanford Site in Washington State. This version of the specification establishes system-level requirements for the DST System that are applicable to the first phase (Phase 1) of the TWRS mission described in HNF-SD-WM-MAR-008. Moreover, this specification does not specify requirements for the DST System for either the Phase 2 or the system closure period. The basis for Phase 2 and closure phases are expected to be developed over the next few years. This specification will be used as the basis for assessing the existing DST System against the needs of the Phase 1 mission and as the basis for developing subsystem/component specifications. The requirements of this specification will be allocated to subsystems and components as further analysis and system definition dictate.

Several of the Phase 1 requirements are recommended values designated by the acronym, TBR (to be refined). The TBR requirements are based on technical and programmatic assumptions that cannot be validated at this time. Factors preventing validation of assumptions include uncertainties in (1) the requirements of the Phase 1 contracts which have not yet been negotiated, (2) waste volumes to be generated through other missions including salt well pumping, and (3) the processing characteristics of individual tank wastes. These requirements (or recommended values, as appropriate) will be updated as additional information becomes available.

Recommended values for Phase 1 requirements will be converted to final requirements after assumptions are validated. Assumptions related to the Phase 1 contracts will be validated after the contracts are executed as early as May 1998. Assumptions related to the processing characteristics of the waste will be validated following completion of laboratory-scale processing tests. Assumptions related to other DST missions such as salt well pumping and potential use of DSTs to store K Basin waste will be validated after plans and modeling of impacts have been completed.

The existing DST System will be used as the point of departure for the Phase 1 DST System design. An authorization basis governing the existing system has been approved and is contained in HNF-SD-WM-BIO-001, *TWRS Basis for Interim Operation* (BIO), and other documents. These requirements will also be used as a point of departure for safety requirements.

However, as the DST System design evolves for Phase 1, authorization basis requirements may be modified to more adequately address specific operational scenarios and configurations. Requirements derived from the authorization basis are designated by the acronym AB in parentheses (AB).

## 1.2 DOUBLE-SHELL TANK SYSTEM SEGMENT OVERVIEW

### 1.2.1 Relationship to Hanford Site Missions

The primary mission of the Hanford Site is to safely clean up and manage the site's wastes. This mission was broken down into a series of functions and requirements that were allocated to major facilities on the Hanford Site. A Hanford Site Technical Database (HSTD) (HNF-SD-TWR-CSUD-001, HNF-SD-WM-013) was created in RDD-100™ (database program by Ascent Logic Corporation) to manage these requirements and associated major facility definitions. This database forms one cornerstone for defining requirements for major Hanford Site systems such as TWRS. A major portion of the cleanup mission (specific major facilities and associated HSTD requirements) has been allocated to TWRS, as defined in HNF-SD-WM-MAR-008.

The primary functions of the TWRS mission are to (1) store, prepare, immobilize, and package wastes already stored in the DST System; (2) accept new wastes from specific Hanford Site waste generators; (3) permanently store immobilized low-activity waste (LAW); and (4) provide interim storage of immobilized high-level waste (HLW) before permanently storing immobilized HLW in a geologic repository. Nine of the major facilities identified in the HSTD have been allocated to TWRS to accomplish this mission; one of which is the DST System. The major facilities that will perform the TWRS mission are shown in Figure 1-1. The relationships among these major facilities are diagrammed in the TWRS Operation and Maintenance (O&M) Scenario Flow Diagram (Figure 1-2).

The HSTD identifies top-level functions down to the level where they are wholly performed by a major facility. Figure 1-3 shows the major facilities and functions allocated to TWRS. Functions allocated to the DST System are collected below the box representing that system. The purpose of this specification is to define the required performance characteristics of the DST System for Phase 1. The specification collects requirements allocated to the system from the HSTD and drives the requirements for all subordinate subsystems and components. A more complete discussion of this specification, its relationship to other basis documents, and how it ties to the HSTD was provided in the updated *Tank Waste Remediation System Systems Engineering Management Plan* (HNF-SD-WM-SEMP-002). Requirements traceability reports will be available once the data from this specification is input to HSTD. Currently, HSTD contains requirements traceability reports for about half of the requirements and recommended values contained in this specification.

Figure 1-1. Hanford Site Technical Baseline Major Facilities Allocated to Tank Waste Remediation System.

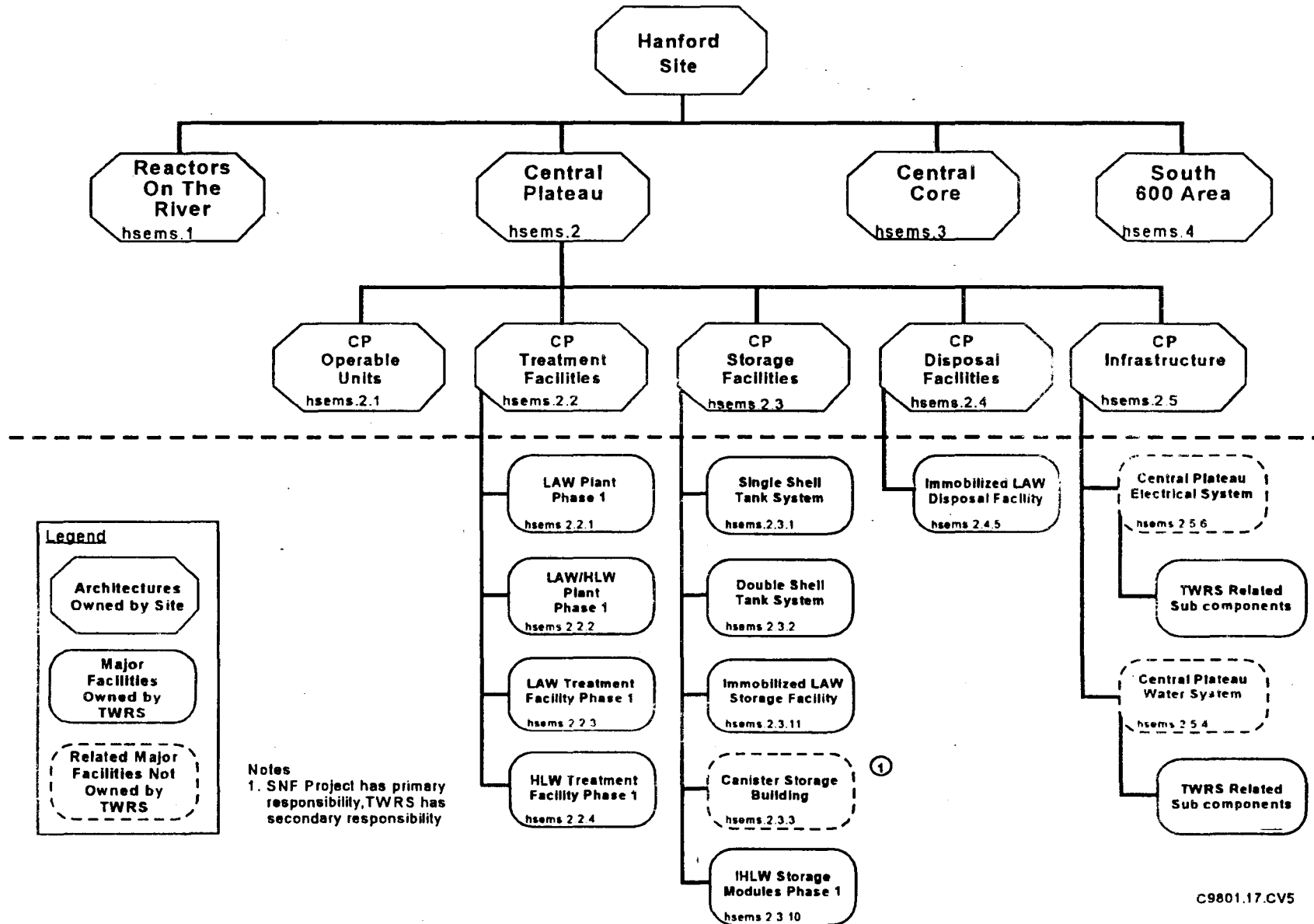

3

**Legend**

- Architecture Owned by Site
- Major Facilities Owned by TWRS
- Related Major Facilities Not Owned by TWRS

**Notes**  
 1. SNF Project has primary responsibility, TWRS has secondary responsibility

Revision D

Figure 1-2. Tank Waste Remediation System Operation and Maintenance Scenario Flow Diagram.

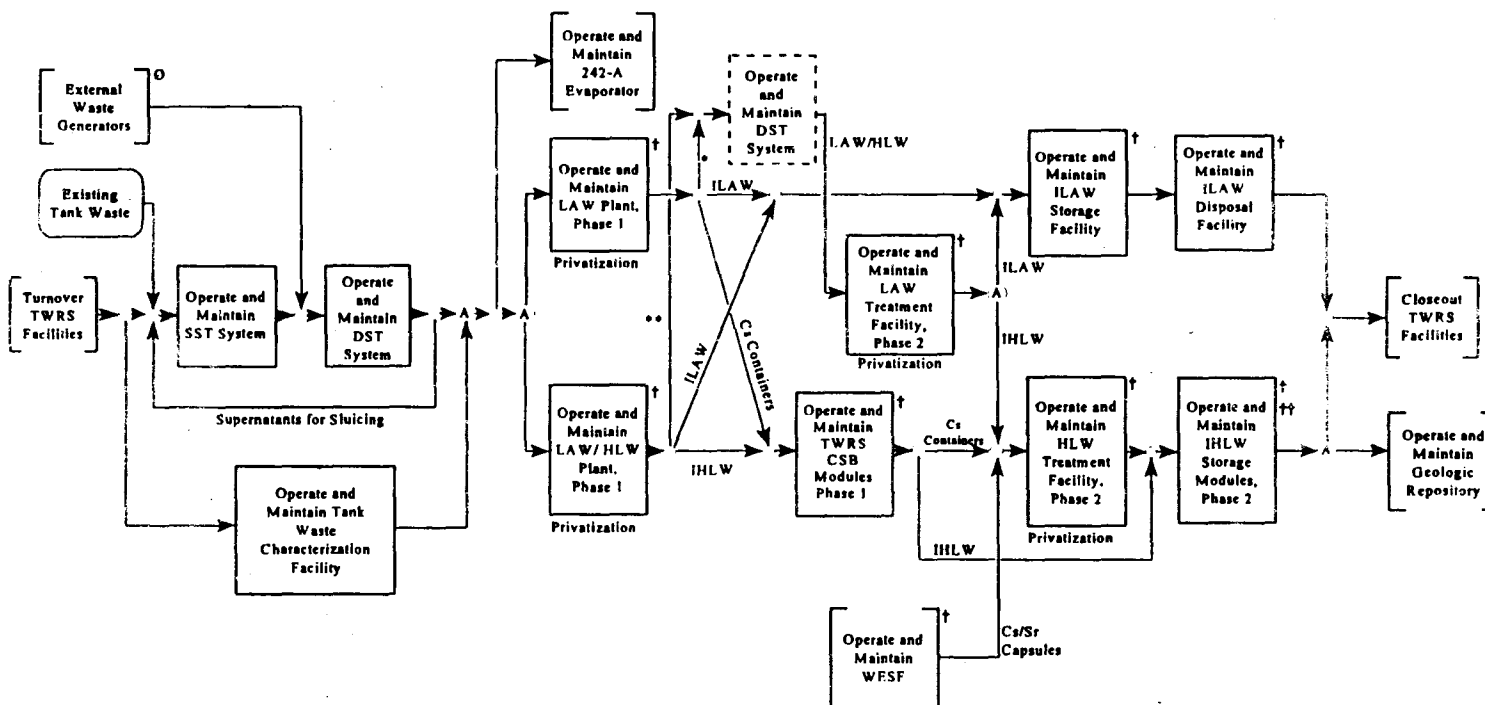

- ° Entrained solids and, as permitted, <sup>99</sup>Tc and <sup>90</sup>Sr/TRU
- \*\* Entrained solids only
- o See Double-Shell Tank Flow for a break-out of External Waste Generators
- † This scenario contains transport of product (e.g., Immobilized LAW)
- †† TRU Not Separate for Tank Waste

- Legend**
- CSB = Container Storage Building
  - DST = Double-Shell Tank
  - HLW = High-Level Waste
  - IHLW = Immobilized High-Level Waste
  - ILAW = Immobilized Low-Activity Waste
  - LAW = Low-Activity Waste
  - O&M = Operations and Maintenance
  - SST = Single-Shell Tank
  - TRU = Transuranic
  - TWRS = Tank Waste Remediation System
  - WESF = Waste Encapsulation Storage Facility

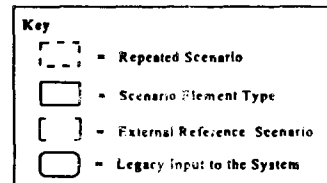

- Notes:**
- Definitions for each O&M scenario are in the Hanford Site Technical Database.
  - This flow is a collection and logical linking of O&M Scenarios for the major facilities that the TWRS Project claims responsibility for at some point in the facility life-cycle phase.

Figure 1-3. Functions Allocated to Tank Waste Remediation System Architectures.

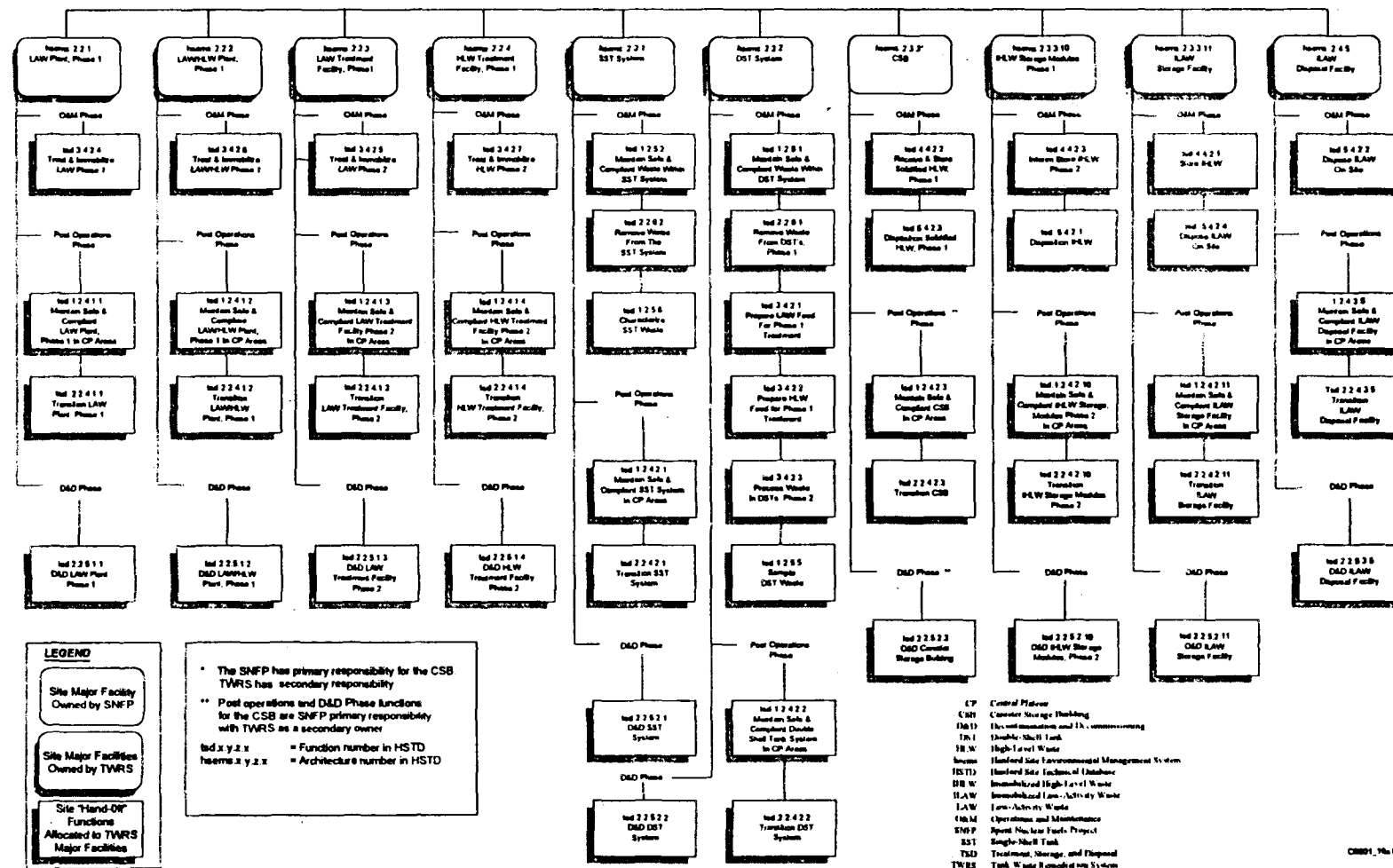



### 1.2.2 Double-Shell Tank System Purpose

The DST System is a major facility performing a significant part of the TWRS mission. The purpose of the DST system is to store tank waste already in the system, receive and store waste from the Single-Shell Tank (SST) System and onsite waste generators, separate waste into LAW and HLW components, deliver separated waste to the immobilization facility feed tanks, and accept waste byproducts from these facilities. The system will comply with appropriate federal, state and Hanford Site regulations. A more detailed description of this system's functions is provided in Section 3.1.

The TWRS Environmental Impact Statement (EIS) (DOE/EIS-0189)/Record of Decision (ROD) (62 FR 8693) and HNF-SD-WM-MAR-008 divide the mission into two waste treatment phases, which are to be followed by tank farm closure. Phase 1 will demonstrate the capability to immobilize both LAW and HLW by processing a specified amount of waste from the DSTs. The DST System will still contain a significant quantity of waste when this portion of the TWRS mission is completed. Phase 2 will include full-scale processing of the remaining underground storage tank waste, including that contained in DSTs, SSTs, and miscellaneous underground storage tanks (MUSTs). Phase 2 operations are planned to start approximately 9 years after the start of Phase 1 and are not yet well defined. The functions and requirements defined in this specification support only Phase 1 and other TWRS missions defined in *Tank Waste Remediation System Operational Waste Volume Projection* (HNF-SD-WM-ER-029).

## 1.3 DOCUMENT OVERVIEW

This document is a technical specification containing system-level requirements and recommended values for the DST System. The document is organized as follows.

Section 1.0 identifies the system defined by this specification, provides a general description of the purpose of the system, and provides this document overview.

Section 2.0 identifies documents that form a part of this specification by reference. Documents listed in this section are cited in later sections of the specification as requirements. This section does not contain a complete list of all documents used to establish requirements but only those explicitly cited.

Section 3.0 provides a definition of the DST System and specifies the requirements that define and constrain the system. This section is divided into eleven major subsections, eight of which apply to the DST System. The subsections are described below.

- Section 3.1 defines the DST System, both in terms of its functional behavior and its system architecture. The behavior is diagrammed using functional flow block diagrams. The system architecture is represented in block diagrams. This high-level

specification shows architecture at an abstract level and avoids assumptions of specific technical solutions for subsystems that have not yet been fully defined.

- Section 3.2 contains system characteristics (e.g., functional requirements [based on the functional flow block diagrams]); quantified performance levels for each function; interface requirements with other major facilities or systems external to the DST System; constraints on system quality factors (e.g., reliability and design life); natural and induced environmental conditions that affect the system (e.g., earthquakes, weather, radiation); and flexibility and expansion requirements that enable future system enhancements.
- Section 3.3 specifies design and construction requirements imposed on the system by external sources. These requirements apply to design and are often not directly derivable from the mission. These requirements will either be worked into the functionality of subsystems and components or passed down to the appropriate end item specification to be incorporated into the design. Categories of requirements in this section include material, process and design practice requirements, electromagnetic radiation resistance, safety, and human factors.
- Section 3.4 identifies required standards for documenting system design requirements.
- Section 3.5 specifies requirements to the system designer for maintaining and supporting the system.
- Section 3.6 identifies personnel and training requirements that must be integrated into system design.
- Section 3.7 identifies the subsystems and components that compose the DST System. The purpose of each subordinate item, a description of its purpose, a description of the system capabilities, and inter-relationships among subordinate items are discussed. This section contains general information based on nontechnology-specific expectations. When the Alternative Generation Analyses (AGAs) are complete, this section will be updated.
- Section 3.8 specifies the order of precedence of documents cited by this specification and/or of the requirements within the specification. Guidance is provided to system developers regarding which requirements and/or sources take precedence over others in the event of a conflict among them.

- Section 3.9 states specific tests under which specific conditions are to be used to verify the system meets the requirements of this specification. This section is a companion to Section 4 which identifies which system capabilities shall be verified by test.
- Section 3.10, "Standard Sample," is not applicable to the DST System.
- Section 3.11, "Preproduction Standard," is not applicable to the DST System.

Section 4.0 identifies the required means for verifying that the system design will perform as specified in Section 3.0. The information in this section will be used to show acceptability of design before onsite construction.

Section 5.0 specifies requirements, if any, for packaging and handling system components for delivery to the site.

Section 6.0 contains information helpful to understanding this document (e.g., important terminology definitions, major assumptions). This section contains no requirements.

Section 7.0 contains the appendix that provides supplemental information published separately to support document maintenance. This specification revision provides traceability to the reference source document for each requirement in this section. Traceability to HNF-SD-WM-MAR-008 will reside in the HSTD.

## 2.0 APPLICABLE DOCUMENTS

The requirements applicable to the DST System mission come from government and nongovernment source documents. These documents define requirements for the system's design, its products and effluents, and other interfaces for successful completion of the TWRS mission. Each document identified in this section is referenced in this specification and represents a part of the specification.

### 2.1 GOVERNMENT SOURCES

DOE orders and regulatory documents, including those promulgated by the federal and Washington State government, are the bases for parts of this specification to the extent specified herein. Documents that form a part of this specification are listed below.

#### **Federal Documents**

##### **Code of Federal Regulations (CFRs)**

40 CFR 264	<i>Standards for Owners and Operators of Hazardous Waste Treatment, Storage, and Disposal Facilities</i>
40 CFR 265	<i>Interim Status Standards for Owners and Operators of Hazardous Waste Treatment, Storage and Disposal Facilities</i>
47 CFR 15	<i>Federal Communication Commission Rules and Regulations</i>
• Subpart B	• <i>Emergency Management Center Regulations</i>

##### **U.S. Department of Energy (DOE) Orders**

DOE 6430.1A	<i>General Design Criteria</i>
-------------	--------------------------------

#### **State Documents**

##### **Washington Administrative Codes (WACs)**

WAC 173-200	<i>Water Quality Standards for Ground Waters in the State of Washington</i>
WAC 173-201A	<i>Water Quality Standards for Surface Waters in the State of Washington</i>

HNF-SD-WM-TRD-007  
Revision D

WAC 173-240	<i>Submission of Plans and Reports for Construction of Waste Water Facilities</i>
WAC 173-303	<i>Dangerous Waste Regulations</i>
WAC 173-360	<i>Underground Storage Tank Regulations</i>

## 2.2 NONGOVERNMENT DOCUMENTS

The Hanford Site documents listed below form a basis for part of this specification to the extent specified herein. Note: The HNF-PROs implement federal and state regulations and DOE orders. Prior to their use, it is the responsibility of the designer to verify these HNF-PROs remain compliant with the latest revision of their parent regulations and with the DOE orders imposed by contract.

### **Hanford Site Procedures**

HNF-PRO-057	<i>Hanford General Employee Training</i>
HNF-PRO-097	<i>Design and Evaluation</i>
HNF-PRO-153	<i>Nuclear Process Operator Training Program</i>
HNF-PRO-154	<i>Responsibilities and Procedures for All Hazardous Material</i>
HNF-PRO-155	<i>Operations Management Fundamentals Training Program</i>
HNF-PRO-156	<i>Nonradioactive Hazardous Material/Waste Shipments</i>
HNF-PRO-157	<i>Radioactive Hazardous Material/Waste Shipments</i>
HNF-PRO-158	<i>Shipping and Receiving in the 1100 Area</i>
HNF-PRO-159	<i>ALARA Program Description</i>
HNF-PRO-160	<i>Cargo Tanks</i>
HNF-PRO-161	<i>Criticality Safety Training Program Description</i>
HNF-PRO-162	<i>Temporarily Upgrading Non-exempt Employees to Exempt</i>
HNF-PRO-163	<i>Documentation and Record Keeping</i>
HNF-PRO-222	<i>Quality Assurance Records</i>
HNF-PRO-224	<i>Document Control</i>
HNF-PRO-242	<i>Engineering Drawing Requirements</i>
HNF-PRO-334	<i>Criticality Safety General Requirements</i>

HNF-SD-WM-TRD-007

Revision D

HNF-PRO-394	<i>Physical Protection of Properties and Facilities</i>
HNF-PRO-445	<i>Design Verification Requirements</i>
HNF-PRO-451	<i>Regulated Substance Management</i>
HNF-PRO-452	<i>NEPA, SEPA, Cultural and Natural Resources</i>
HNF-PRO-455	<i>Solid Waste Management</i>
HNF-PRO-537	<i>Criticality Safety Control of Fissionable Material</i>
HNF-PRO-538	<i>Criticality Safety Training</i>
HNF-PRO-539	<i>Criticality Safety Evaluation</i>
HNF-PRO-540	<i>Criticality Prevention Specifications</i>
HNF-PRO-541	<i>Criticality Safety Postings</i>
HNF-PRO-542	<i>Criticality Liability Fissionable Material</i>
HNF-PRO-543	<i>Fissionable Material Storage</i>
HNF-PRO-544	<i>Criticality Plant Configuration Control</i>
HNF-PRO-545	<i>Fissionable Material Packaging and Transportation</i>
HNF-PRO-546	<i>Criticality Alarm System</i>
HNF-PRO-547	<i>Criticality Safety for Firefighting</i>
HNF-PRO-548	<i>Criticality Safety Inspections and Assessments</i>
HNF-PRO-549	<i>Criticality Safety Nonconformance Response</i>
HNF-PRO-550	<i>Criticality or Potential Criticality Accidents</i>
HNF-PRO-700	<i>Safety Analysis and Technical Safety Requirements</i>
HNF-PRO-701	<i>Safety Analysis Process-Existing Facility</i>
HNF-PRO-702	<i>Safety Analysis Process-Facility Change or Modification</i>
HNF-PRO-703	<i>Safety Analysis Process-New Project</i>
HNF-PRO-704	<i>Hazard and Accident Analysis Process</i>

## HNF-SD-WM-TRD-007

Revision D

### Other Hanford Site Documents

HNF-2004, Rev. 0	<i>Estimated Dose to In-Tank Equipment: Phase 1</i>
HNF-2288	<i>Miscellaneous Supporting Information for: System Specification for the Double-Shell Tank System (HNF-SD-TRD-007)</i>
HNF-MP-599	<i>Project Hanford Quality Assurance Program Description</i>
HNF-SD-WM-BIO-001, Rev. 0-G	<i>Tank Waste Remediation System Basis for Interim Operation</i>
HNF-SD-WM-DQO-001, Rev. 2	<i>Data Quality Objectives for Tank Farm Waste Compatibility Program</i>
HNF-SD-WM-DTR-046, Rev. 0	<i>Results of Dilution Studies with Waste from Tank 241-A-105</i>
HNF-SD-WM-TR-026	<i>Tank Waste Remediation System Dangerous Waste Training Plan</i>
HNF-SD-WM-TSR-006, Rev. 0-I	<i>Tank Waste Remediation System Technical Safety Requirements</i>
HSRCM-1, Rev. 2	<i>Hanford Site Radiological Control Manual</i>
OSD-T-151-00007	<i>Unclassified Operation Specifications for the 241-AN, AP, AW, AY, AZ, &amp; SY Tank Farms</i>
WHC-CM-7-5	<i>Environmental Compliance</i>
WHC-SD-GN-ER-501, Rev. 0-A	<i>Natural Phenomena Hazards, Hanford Site, South-Central Washington</i>
WHC-SD-WM-DQO-014, Rev. 1-A	<i>242-A Evaporator/Liquid Effluent Retention Facility Data Quality Objectives</i>
WHC-SD-WM-EV-053, Rev. 4	<i>Double-Shell Tank Waste Analysis Plan</i>
WHC-SD-WM-HSP-002, Rev. 2-F	<i>Tank Farm Health and Safety Plan</i>
WHC-SD-WM-OCD-015, Rev. 1	<i>Tank Waste Farm Transfer Compatibility Program</i>

If there is a conflict between site procedures and source documents, source documents will take precedent.

### 3.0 DOUBLE-SHELL TANK WASTE RETRIEVAL SYSTEM FUNCTIONS AND REQUIREMENTS

#### 3.1 SYSTEM DEFINITION

##### 3.1.1 Functional Description—Double-Shell Tank System

The DST System O&M flow (Figure 3-1) shows the relationships between seven of the nine DST functions. (The two omitted functions do not relate to the DST System O&M phases and are not relevant to this specification.) Five of these functions will be performed during Phase 1. These five functions, together with their subordinate functions, are listed in Table 3-1. The remaining two functions will be performed after Phase 1 and are not relevant to this specification. The relationship among the subordinate functions is diagrammed in the DST System functional flow block diagram (Figure 3-2), which illustrates the DST System functional behavior, shows how waste will flow from its sources through the DST System to the privatized vitrification plants, and shows byproduct waste flow returning from the plants back into the DST System.

Table 3-1. Phase 1, Double-Shell Tank System Functions.

<p><b>Maintain Safe and Compliant Waste within the DST System</b></p> <ul style="list-style-type: none"> <li>• Store Waste in West Area DSTs</li> <li>• Store Waste in East Area DSTs</li> <li>• Transfer Waste from 204-AR Waste Unloading Facility to East Area DSTs</li> <li>• Receive New Liquid Waste into West Area DSTs</li> <li>• Receive New Liquid Waste into East Area DSTs</li> <li>• Receive Concentrated Waste from Evaporator</li> <li>• Receive Emergency Purge from Evaporator</li> <li>• Receive Waste Products from LAW/HLW and LAW Treatment</li> </ul>	<p><b>Remove Waste from DSTs, Phase 1</b></p> <ul style="list-style-type: none"> <li>• Prepare Waste in West Area DSTs</li> <li>• Transfer Waste Between West Area DSTs</li> <li>• Transfer Waste Cross-Site</li> <li>• Prepare Waste in East Area DSTs</li> <li>• Transfer Waste Between East Area DSTs</li> <li>• Transfer Waste for Concentration</li> <li>• Transfer Waste to LAW Staging Tanks</li> </ul>
<p><b>Prepare LAW Feed for Phase 1 Treatment</b></p> <ul style="list-style-type: none"> <li>• Blend LAW in LAW Staging Tanks</li> <li>• Transfer LAW Supernatants to Vendor Feed Storage</li> </ul>	<p><b>Prepare HLW Feed for Phase 1 Treatment</b></p> <ul style="list-style-type: none"> <li>• Perform Enhanced Sludge Washing (In-tank)</li> <li>• Transfer Sludge Wash Supernatants to East DSTs</li> <li>• Prepare HLW Solids in Sludge Washing Tanks</li> <li>• Transfer HLW Sludge to LAW/HLW Plant</li> </ul>
	<p><b>Sample DST Waste</b></p>

DST = double-shell tank.  
HLW = high-level waste.  
LAW = low-activity waste.



Figure 3-1. Level 4 Double-Shell Tank System Operations and Maintenance Flow.

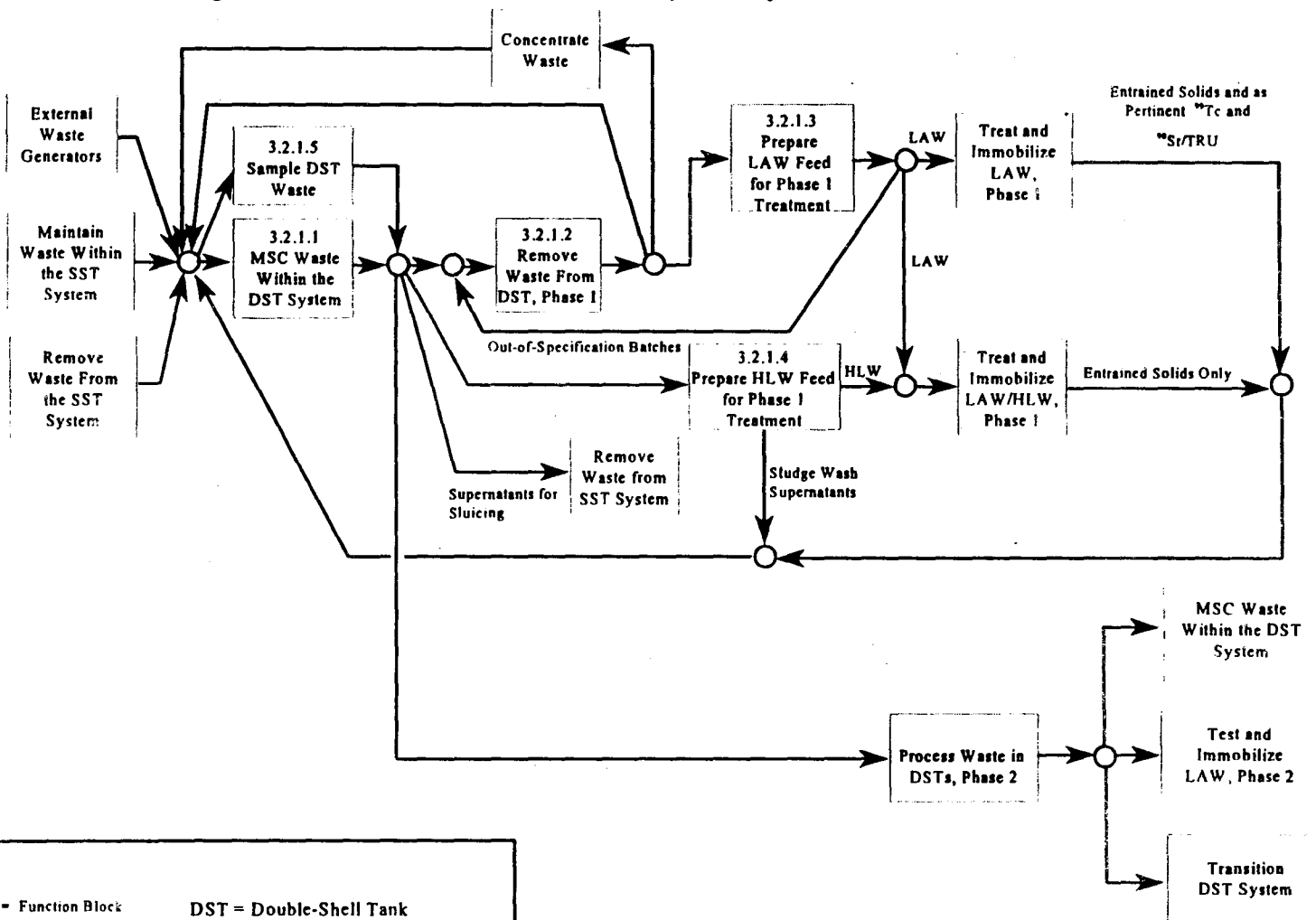

Key	
- Function Block	DST = Double-Shell Tank
- External Functions	HLW = High-Level Waste
- Repeated Functions	LAW = Low-Activity Waste
	MSC = Maintain Safe and Compliant
	SST = Single-Shell Tank

Note: Numbers in the boxes are the section containing the functional and performance requirements.

Figure 3-2. Double-Shell Tank System Functional Flow Block Diagram (Sheet 1 of 3).

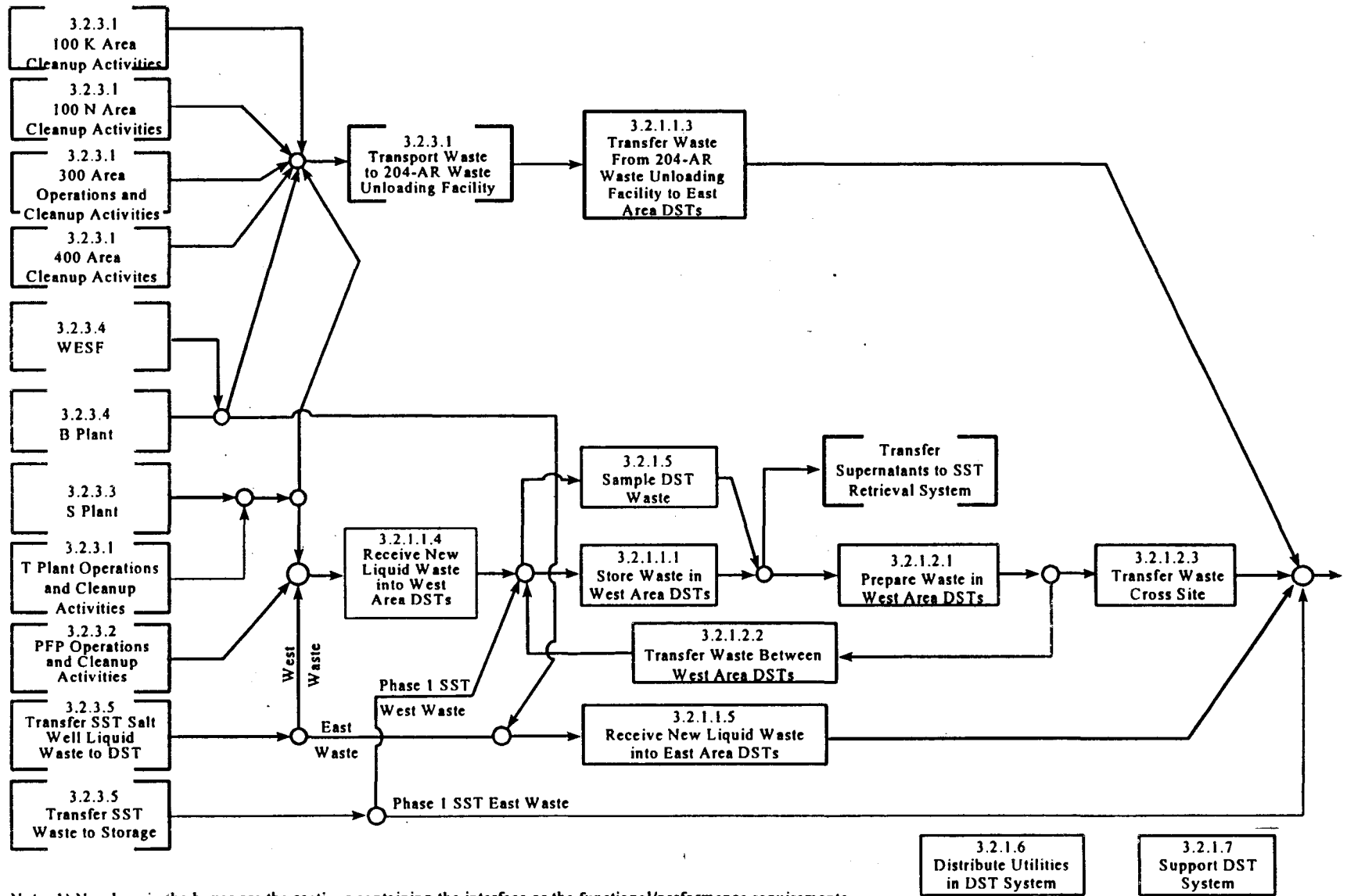

Note: 1) Numbers in the boxes are the sections containing the interface or the functional/performance requirements.

Greard/FIG3-2AA WPG

Figure 3-2. Double-Shell Tank System Functional Flow Block Diagram (Sheet 2 of 3).

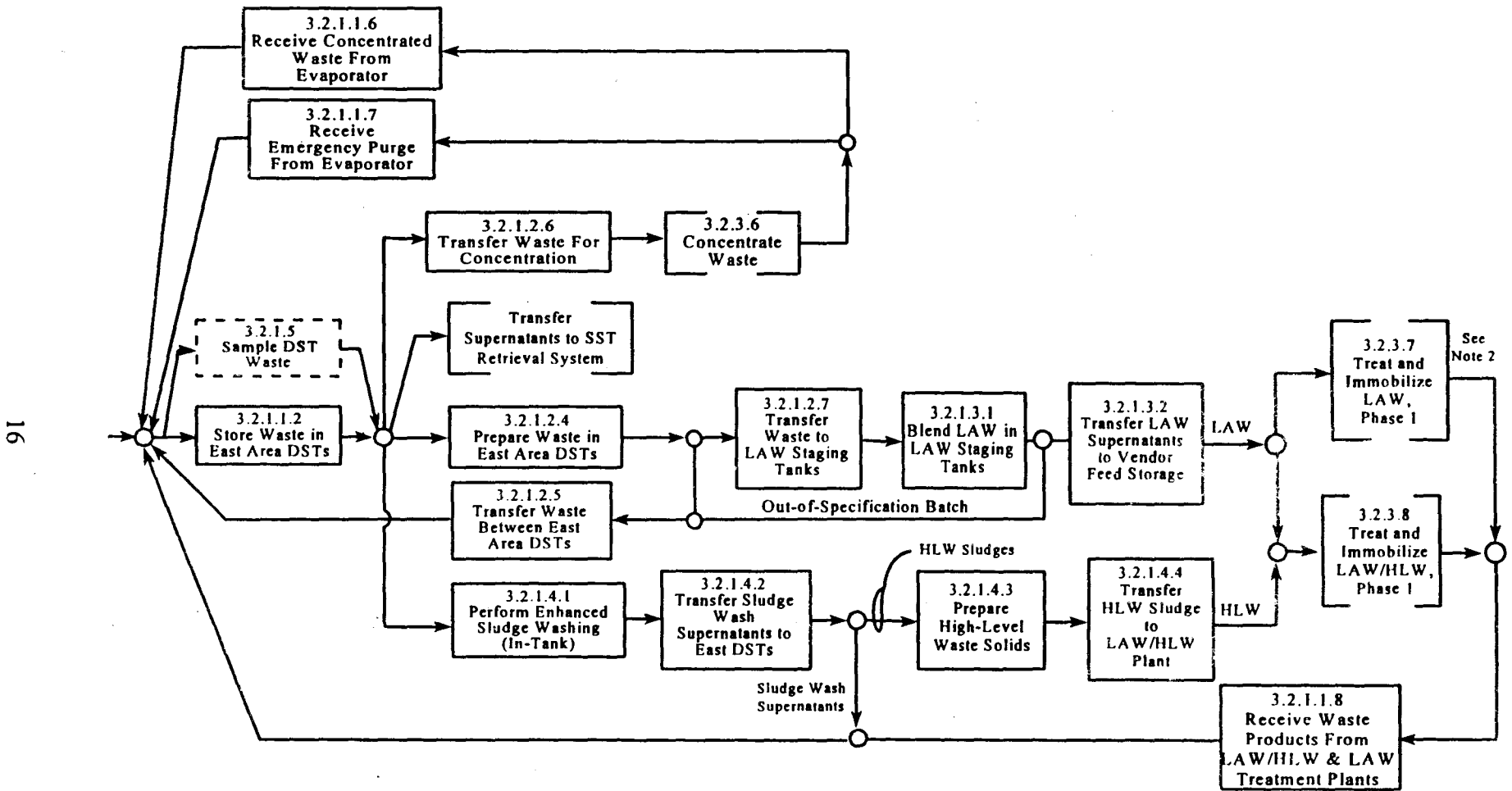

Note: 1) Numbers in the boxes are the sections containing the functional and performance requirements.

2) Waste Products: entrained solids and, as permitted, <sup>99</sup>Tc and <sup>90</sup>Sr/transuranic.

Grand/FIG3-2ba WPG

Figure 3-2. Double-Shell Tank System Functional Flow Block Diagram (Sheet 3 of 3).

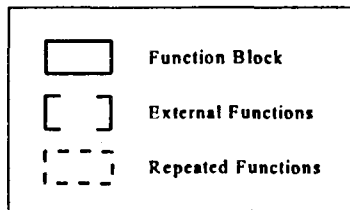
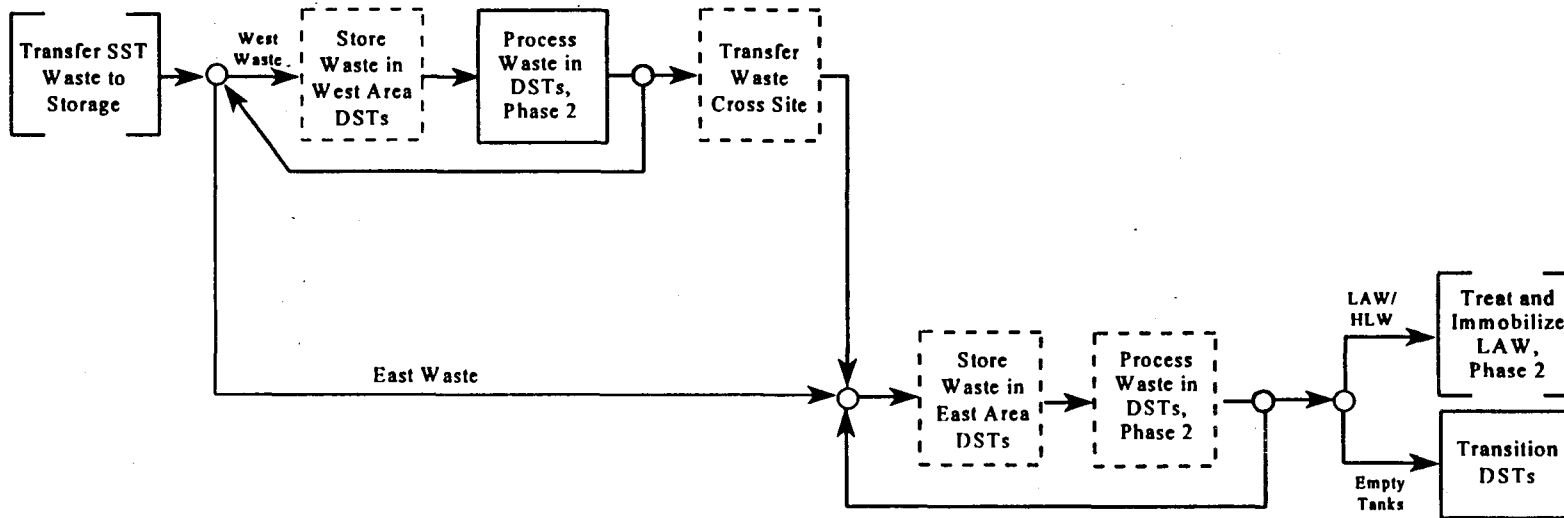

DST = Double-Shell Tank  
 HLW = High-Level Waste  
 LAW = Low-Activity Waste  
 PFP = Plutonium Finishing Plant  
 SST = Single-Shell Tank  
 WESF = Waste Encapsulation and Storage Facility

**3.1.2 System Description**

The DST System is a major facility that interfaces with other Hanford Site major facilities (Figure 3-3). The DST System receives additional waste from the SST System and onsite waste generators, delivers waste to the evaporator, receives concentrated waste from the evaporator, and delivers waste to the immobilization facilities (i.e., the LAW and LAW/HLW Plants). The 222-S Laboratory analyzes waste samples from the DST Systems in support of safe storage, retrieval, and processing.

The existing DST System consists of the items listed in Table 3-2. Figure 3-4 shows the relationship among these elements. The gray boxes on this figure represent elements required for Phase 1 that do not exist today. The system includes six tank farms containing 28 DSTs. The system will contain 26 DSTs after two tanks are turned over to the vitrification private contractor. Five of the tank farms are located in the 200 East Area; one is located in the 200 West Area. The four tanks in the 241-AY and 241-AZ tank farms are designed to store high heat or “aging” waste and have a design storage capacity of 3,800 m<sup>3</sup>/tank (1 Mgal/tank). All other DSTs have a design capacity of 4,390 m<sup>3</sup>/tank (1.16 Mgal/tank).

Table 3-2. Double-Shell Tank, Existing System Items.

200 East Area	200 West Area
241-AN Farm (seven tanks)	241-SY Farm (three tanks)
241-AP Farm (eight tanks)	244-TX Receiver Tank (DCRT)*
241-AW Farm (six tanks)	244-U Receiver Tank (DCRT)*
241-AY Farm (two tanks/two diversion boxes)	244-S Receiver Tank (DCRT)*
241-AZ Farm (two tanks)	West Area DST Transfer System
244-A Receiver Tank (DCRT)*	Cross-site Transfer System
244-BX Receiver Tank (DCRT)*	
244-AR Vault*	
244-CR Vault*	
East Area DST Transfer System	
204-AR Facility	

\*Miscellaneous underground storage tanks assigned to the DST System.

DCRT = double-contained receiver tank.

DST = double-shell tank.

TWRS contains MUSTs used (1) as catch tanks, neutralization tanks, settling tanks, and receiving vault tanks; (2) for waste handling in the tank farm system; (3) for uranium recovery support; or (4) to support waste handling from a specific facility. Responsibility for 36 inactive MUSTs and 12 active MUSTs has been assigned to TWRS (HNF-SD-WM-MAR-008). Active

Figure 3-3. Double-Shell Tank System Interface Diagram.

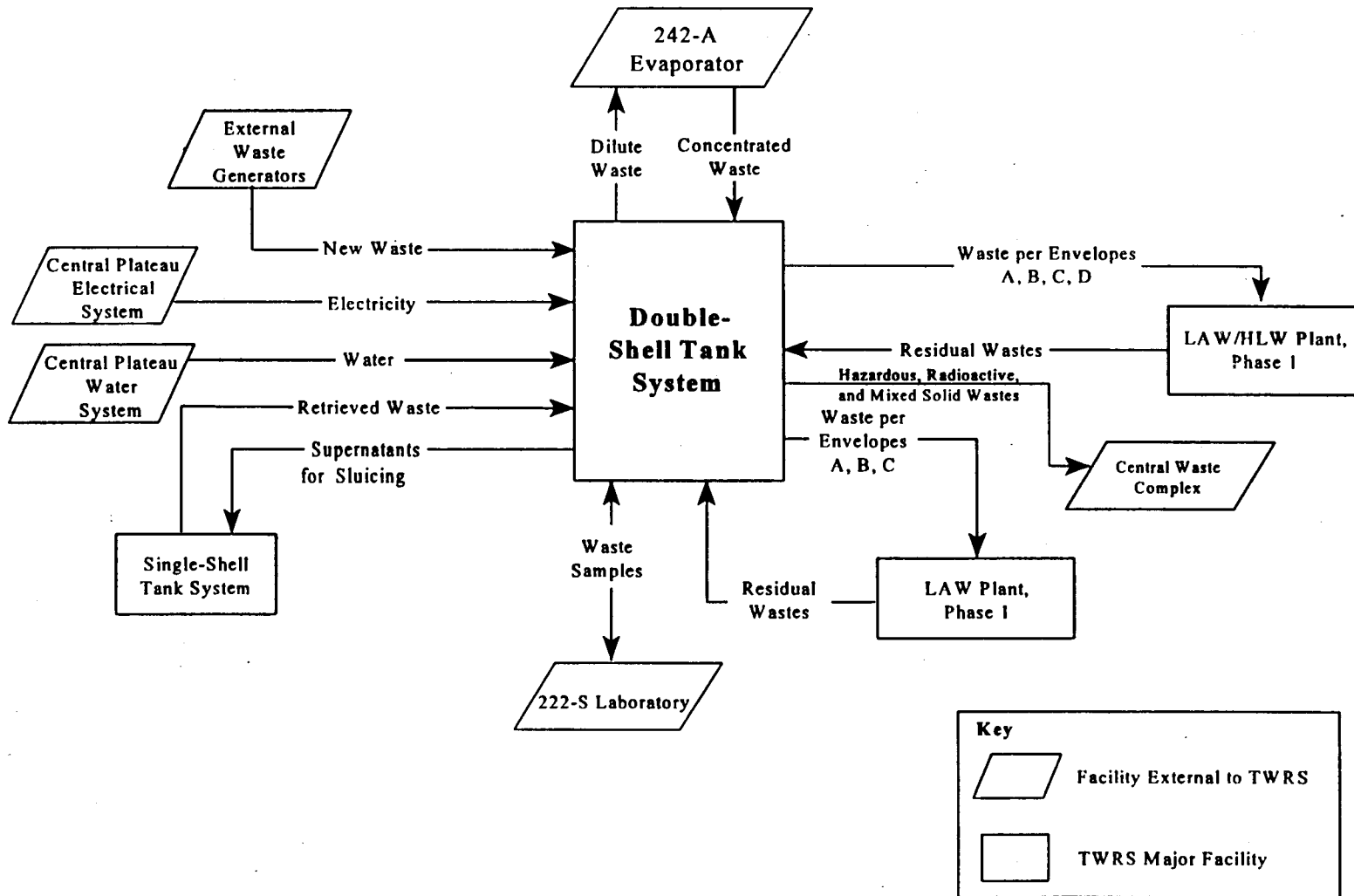

**Key**

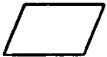
 Facility External to TWRS

 TWRS Major Facility

HLW = high-level waste.  
LAW = low-activity waste.

HNF-SD-WM-TRD-007  
Revision D

HNF-SD-WM-TRD-007  
Revision D

Figure 3-4. Phase 1 Double-Shell Tank System.

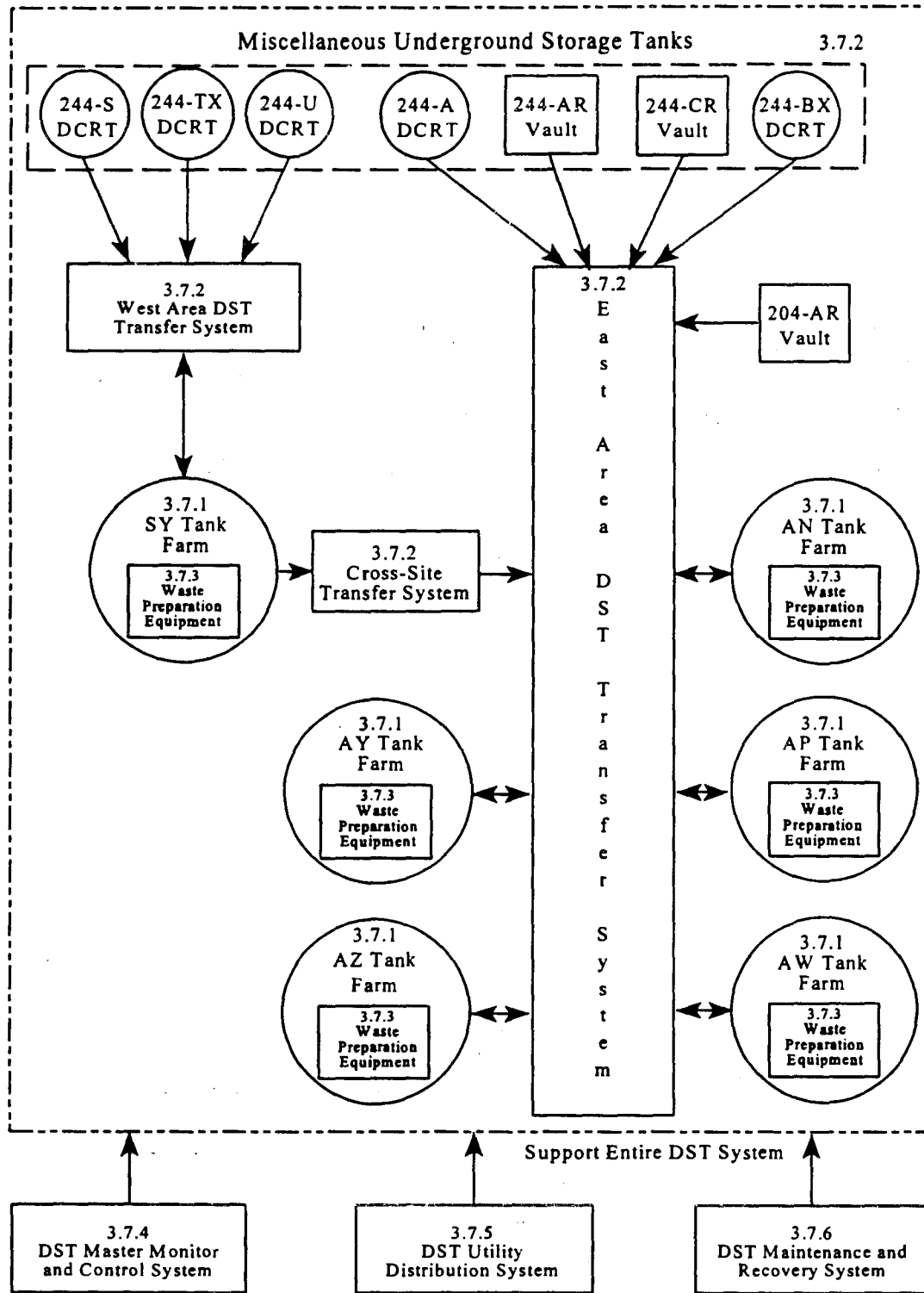

DCRT = Double-Contained Receiver Tank

DST = Double-Shell Tank

Notes: - Numbers in the boxes and circles are the sections containing subsystem descriptions

- Shaded boxes are new architecture items added as a consequence of Claghorn et al. 1997.

Grand6/FIG3-5a WPG

MUSTs that have been allocated to the DST System are included in Table 3-2. The remainder of MUSTs have not been allocated to a major facility at this time.

Waste is moved between the DSTs in each area by the transfer systems using underground pipelines. These pipelines include diversion boxes and valve pits to direct waste to its destination. The system also has two cross-site transfer lines to move waste between the 200 West Area and the 200 East Area.

Other items in the DST System include five double-contained receiver tanks (DCRTs), the 244-AR and 244-CR vaults, and the 204-AR Unloading Facility. The DCRTs are used to collect liquid waste from the SSTs (e.g., salt well pumping liquor) before transfer to a DST.

The 244-AR vault was used to condition waste from the Plutonium-Uranium Extraction Facility (PUREX) before the waste was transferred to a DST and to prepare waste for processing in B Plant during campaigns to recover cesium and strontium from the waste. The 244-AR vault has been decommissioned but still contains waste that must be removed before the vault can be closed. The 244-CR vault was used to store sludge dissolved during the cesium and strontium recovery campaigns. It is currently used, like a DCRT, to accumulate waste from the SSTs before transfer to a DST.

The 204-AR Unloading Facility receives waste transported to the DST System by tank truck or rail tank car and transfers the waste to an East Area DST. This facility includes chemical adjustment capability to ensure waste transferred from the facility will meet DST System waste composition requirements.

Figure 3-4 shows three system elements that support all other system elements: the master monitor and control system, the utilities distribution system, and the maintenance and recovery system. The existing master monitor and control system (i.e., the Tank Monitor and Control System) provides monitoring of some DST farm parameters. The utilities distribution system receives electrical power and water from the site and distributes them throughout the DST System, providing utilities that are wholly contained within the DST System. The support services function provides offices, change rooms, and other facilities necessary for operation of the system, training of personnel, and equipment for recovery from off-normal events.

## **3.2 SYSTEM CHARACTERISTICS**

The following sections specify the characteristics of the DST System.

### **3.2.1 Performance Characteristics**

The system shall function to the levels specified below.



**3.2.1.1 Maintain Safe and Compliant Waste within the Double-Shell Tank System.** The DST System shall store existing tank waste and waste received from the SST System and onsite waste generators in DSTs.

a. **Double-Shell Tank System Storage Capacity, Phase 1.** The system shall provide the means to store at least 120,000 m<sup>3</sup> (31.8 Mgal) of waste until two tanks are turned over to Phase 1 privatization contractors; thereafter, the system shall be capable of storing at least 112,000 m<sup>3</sup> (29.5 Mgal) of waste through the end of Phase 1.

b. **Double-Shell Tank System Spare Storage Capacity.** The system shall maintain spare capacity with adequate heat dissipation capability to receive the largest volume of liquid contained in any one tank for emergency situations.

**3.2.1.1.1 Store Waste in West Area Double-Shell Tanks.** The system shall store existing waste and waste received from the SSTs and generators in the 200 West Area.

a. **West Double-Shell Tank System Storage Capacity, Phase 1.** The system shall provide the means to store at least 13,000 m<sup>3</sup> (3.5 Mgal) of waste in the 200 West Area DSTs through the end of Phase 1.

**3.2.1.1.2 Store Waste in East Area Double-Shell Tanks.** The system shall store existing waste in the 200 East Area DSTs and waste received from the SSTs, the 200 West Area DSTs, 200 East Area generators, and other generators that use the 204-AR Vault.

a. **East Double-Shell Tank System Storage Capacity, Phase 1.** The system shall provide the means to store at least 107,000 m<sup>3</sup> (28.3 Mgal) of waste in the 200 East Area DSTs until two tanks are turned over to Phase 1 privatization contractors; thereafter, the system shall be capable of storing at least 98,000 m<sup>3</sup> (26 Mgal) of waste through the end of Phase 1.

**3.2.1.1.3 Transfer Waste from 204-AR Waste Unloading Facility to East Area Double-Shell Tanks.** The system shall remove waste from tanker trucks and rail cars parked at the 204-AR Waste Unloading Facility, adjust the waste chemical properties, and transfer it to a 200 East Area DST for storage.

a. **204-AR Annual Capacity.** The system shall have the capacity to transfer at least 1,514 m<sup>3</sup> (0.40 Mgal) (TBR) of waste per year through Phase 1.

b. **204-AR Batch Transfer.** The system shall be capable of unloading batches of up to 18.9 m<sup>3</sup> (5,000 gal) (TBR) in less than or equal to 1 day.

c. **204-AR Transferred Waste Properties.** The system shall transform the wastes specified in the requirement "204-AR Waste Receipt Properties" (Section 3.2.3.1.a) to satisfy the requirements of HNF-SD-WM-DQO-001.

**3.2.1.1.4 Receive New Liquid Waste into West Area Double-Shell Tanks.** The system shall receive waste from 200 West Area waste generators and route it to a 200 West Area DST.

**a. West Area Liquid Waste Annual Capacity.** The system shall be capable of receiving at least 15,000 m<sup>3</sup> (4.0 Mgal) (TBR) of liquid waste per year through Phase 1.

**b. Waste Batch Size—West Area.** The system shall be capable of receiving batches of 4 m<sup>3</sup> (0.001 Mgal) (TBR) to 2,700 m<sup>3</sup> (0.72 Mgal) (TBR) in less than or equal to 9 days. (TBR)

**3.2.1.1.5 Receive New Liquid Waste into East Area Double-Shell Tanks.** The system shall receive waste from 200 East Area waste generators and route it to a 200 East Area DST.

**a. East Area Liquid Waste Annual Capacity.** The system shall be capable of receiving at least 15,000 m<sup>3</sup> (3.9 Mgal) (TBR) of liquid waste per year through Phase 1.

**b. Waste Batch Size—East Area.** The system shall be capable of receiving batches of 20 m<sup>3</sup> (0.005 Mgal) (TBR) to 3,000 m<sup>3</sup> (0.8 Mgal) (TBR) in less than or equal to 9 days. (TBR)

**3.2.1.1.6 Receive Concentrated Waste from Evaporator.** The system shall route concentrated waste from the 242-A Evaporator to 200 East Area DST for storage.

**a. Annual Volume of Concentrated Waste.** The system shall be capable of receiving up to 9,100 m<sup>3</sup> (2.4 Mgal) (TBR) of waste per year through Phase 1.

**b. Concentrated Waste Receipt Rate.** The system shall comply with the requirements for the 242-A Evaporator interface (Sections 3.2.3.6 a and b).

**3.2.1.1.7 Receive Emergency Purge from Evaporator.** The system shall receive waste from the 242-A Evaporator during an emergency purge event.

**a. Evaporator Purge Batch Size.** The system shall comply with the requirements for the 242-A Evaporator interface (Section 3.2.3.6.c).

**3.2.1.1.8 Receive Waste Products from Low-Activity Waste/High-Level Waste and Low-Activity Waste Treatment.** The system shall receive intermediate waste byproducts from the LAW and LAW/HLW treatment plants and route it to a 200 East Area DST.

**a. Treatment Plant Waste Product Volume, Phase 1.** The system shall be capable of receiving at least 500 m<sup>3</sup> (0.13 Mgal) (TBR) of entrained solids and <sup>90</sup>Sr/TRU through the end of Phase 1.

**b. Treatment Plant Waste Receipt Requirements.** The system shall comply with the requirements for the “Phase 1 Low-Activity Waste Plant” (Section 3.2.3.7) and the “Phase 1 Low-Activity Waste/High-Level Waste Plant” (Section 3.2.3.8).

**3.2.1.2 Remove Waste from Double-Shell Tanks, Phase 1.** The system shall remove waste from a DST and send it to another DST or to the 242-A Evaporator.

**a. Low-Activity Waste Staging Quantity, Phase 1.** The system shall be capable of delivering at least 10,500 MT (TBR) of sodium to the LAW staging tanks through the end of Phase 1. The system shall deliver at least 2,000 MT (TBR) of sodium before the start of the Phase 1 Plant operation, 7,000 MT (TBR) of sodium within 5 years after the start of Phase 1 Plant operation, and the balance within 9 years after the start of Phase 1 Plant operation.

**b. Space Management Annual Waste Volume, Phase 1.** The system shall be capable of moving at least 87,000 m<sup>3</sup> (23 Mgal) (TBR) per year of waste through the end of Phase 1 for space management.

**c. Evaporator Feed Volume, Phase 1.** The system shall be capable of delivering up to 17,000 m<sup>3</sup> (4.4 Mgal) (TBR) of waste per year for transfer to the evaporator through the end of Phase 1.

**d. Unretrieved Waste Properties.** The system shall be capable of removing waste forms with the following properties (TBR). Note: These values bound the waste forms within the tanks. Actual application of these values will vary by tank.

Supernatant

Density:	1 - 1.57 g/mL
pH:	8 to 14+
Sodium Molarity:	Up to 14 Molar

Soluble Waste

Solubility:	Soluble waste dissolves within 48 hours using the dissolution kinetics test as described in HNF-SD-WM-DTR-046.
Shear Strength:	6.9 Pa at 300 s <sup>-1</sup> (undiluted settled solids, 45°C) 3.0 Pa at 300 s <sup>-1</sup> (undiluted whole tank composite, 45°C)
Apparent Viscosity:	10,000 to 10,000,000 cP (in situ, unmixed)
Yield Stress:	<500 Pa (in situ, unmixed)

Insoluble Waste

Solubility: Insoluble waste does not dissolve within 48 hours using the dissolution kinetic test as described in HNF-SD-WM-DTR-046.

Shear Strength: 2,210 to 5,360 Pa

**3.2.1.2.1 Prepare Waste in West Area Double-Shell Tanks.** The system shall prepare waste stored in the 200 West Area DSTs for transfer to another 200 West Area DST or cross-site to an East Area DST.

**a. Supernatant Preparation—West Area.** The system shall have the capability to adjust up to 4,400 m<sup>3</sup> (1.16 Mgal) of supernatant to meet the transfer requirements of HNF-SD-WM-DQO-001.

**b. Soluble Waste Preparation—West Area.** The system shall have the capability to transform an operator-selected quantity of soluble waste to achieve a sodium molarity of at least 7.0 (TBR) and to transform the solution to satisfy the transfer requirements of HNF-SD-WM-DQO-001 in no more than 82 days (TBR).

**c. Insoluble Waste Preparation—West Area.** The system shall have the capability to mobilize an operator-selected quantity of insoluble waste and transform it to satisfy the transfer requirements of HNF-SD-WM-DQO-001 in less than or equal to 14 days. (TBR)

**3.2.1.2.2 Transfer Waste Between West Area Double-Shell Tanks.** The system shall transfer waste between West Area DSTs.

**a. 200 West Area Waste Batch Transfer.** The system shall be capable of transferring batches of 100 m<sup>3</sup> (0.03 Mgal) (TBR) to 4390 m<sup>3</sup> (1.16 Mgal) of prepared waste to another 200 West Area DST in 4 to 9 days. (TBR)

**b. Waste Pumpability.** The system shall satisfy the waste pumpability rules of WHC-SD-WM-OCD-015, Section 3.2.5, while transferring waste.

**3.2.1.2.3 Transfer Waste Cross-Site.** The system shall transfer waste from the West Area DSTs to the East Area DSTs.

**a. Cross-Site Waste Transfer Volume.** The system shall be capable of transferring 100 m<sup>3</sup> (0.03 Mgal) (TBR) to 4,390 m<sup>3</sup> (1.16 Mgal) of prepared waste from a 200 West Area DST to a 200 East Area DST in 4 to 9 days (TBR).

**b. Waste Pumpability.** The system shall satisfy the waste pumpability rules of WHC-SD-WM-OCD-015, Section 3.2.5, while transferring waste.

**3.2.1.2.4 Prepare Waste in East Area Double-Shell Tanks.** The system shall prepare waste stored in the 200 East Area DSTs for transfer to another East Area DST or to the 242-A Evaporator.

**a. Supernatant Preparation—East Area.** The system shall have the capability to adjust up to 4,400 m<sup>3</sup> (1.16 Mgal) of supernatant to meet the transfer requirements of HNF-SD-WM-DQO-001.

**b. Soluble Waste Preparation—East Area.** The system shall have the capability to transform an operator-selected quantity of soluble waste to achieve a sodium molarity of at least 7.0 (TBR) and transform the solution to satisfy the transfer requirements of HNF-SD-WM-DQO-001 in no more than 117 days (TBR).

**c. Insoluble Waste Preparation—East Area.** The system shall have the capability to mobilize an operator-selected quantity of insoluble waste and transform it to satisfy the transfer requirements of HNF-SD-WM-DQO-001 in less than or equal to 1 day. (TBR)

**3.2.1.2.5 Transfer Waste Between East Area Double-Shell Tanks.** The system shall transfer waste between East Area DSTs.

**a. 200 East Area Waste Batch Transfer.** The system shall be capable of transferring at least 15 m<sup>3</sup> (0.004 Mgal) (TBR) to 4,390 m<sup>3</sup> (1.16 Mgal) of prepared waste to another 200 East Area DST in 4 to 9 days. (TBR)

**b. Waste Pumpability.** The system shall satisfy the waste pumpability rules of WHC-SD-WM-OCD-015, Section 3.2.5, while transferring waste.

**3.2.1.2.6 Transfer Waste for Concentration.** The system shall transfer waste from the evaporator feed tank (241-AW-102) to the 242-A Evaporator for concentration.

**a. Evaporator Feed Annual Volume.** The system shall be capable of providing up to 17,000 m<sup>3</sup>/yr (4.4 Mgal/yr) (TBR) of dilute supernatant from tank 241-AW-102 for concentration.

**b. Evaporator Feed Rate.** The system shall be capable of transferring waste to the evaporator within a range of 0.00442 m<sup>3</sup>/s (70 gpm) to 0.00757 m<sup>3</sup>/s (120 gpm) for 2 months (AB).

**c. Evaporator Feed Requirements.** The system shall provide evaporator feed with a specific gravity of 1.0 to 1.4 that also satisfies the requirements of (a) no significant exotherm at a temperature below 168 °C (335 °F) and the exotherm/exotherm ratio <1 and (b) no total concentration in excess of the NaNO<sub>3</sub>/NaNO<sub>2</sub> precipitation boundary. The system shall also provide evaporator feed that satisfies requirements in WHC-SD-WM-DQO-014.

**d. Waste Pumpability.** The system shall satisfy the waste pumpability rules of the WHC-SD-WM-OCD-015, Section 3.2.5, while transferring waste.

**3.2.1.2.7 Transfer Waste to Low-Activity Waste Staging Tanks.** The system shall transfer operator-selected waste from the 200 East Area DSTs to the LAW staging tanks.

**a. Low-Activity Waste Staging Batch Volumes.** The system shall be capable of transferring 1,100 m<sup>3</sup> (0.3 Mgal) (TBR) to 3,800 m<sup>3</sup> (1 Mgal) of prepared waste to the LAW feed staging tank in 4 to 9 days. (TBR)

**b. Waste Pumpability.** The system shall satisfy the waste pumpability rules of WHC-SD-WM-OCD-015, Section 3.2.5, while transferring waste.

**3.2.1.3 Prepare Low-Activity Waste Feed for Phase 1 Treatment.** The system shall prepare and qualify waste in the staging tanks as LAW feed and transfer it to the LAW or LAW/HLW Plant feed tanks. The system shall be capable of transferring waste to both facilities but not at the same time.

**a. Low-Activity Waste Feed Composition and Physical Properties, Phase 1.** The system shall deliver independent batches of LAW feed satisfying Envelope A, B, or C as selected by the operator. Envelopes A, B, and C as defined in Tables 3-3 and 3-4 shall have a sodium concentration between 3M and 14M.

**b. Waste Compatibility.** The system shall adjust waste properties to satisfy the waste compatibility rules of the HNF-SD-WM-DQO-001 except the undissolved solids fraction shall be less than or equal to 5 vol%.

**c. Low-Activity Waste Feed Production Quantities, Phase 1.**

1. The system shall produce and deliver at least the minimum order quantities of waste Envelopes A, B, and C (Table 3-5) to each plant within 5 years after the beginning of plant operation.
2. The system shall be capable of producing and delivering up to the maximum order quantity of each envelope (Table 3-5) to each plant within 9 years after the beginning of plant operation; the total quantity of Envelope A, B, and C waste delivered shall not exceed 10,200 MT of sodium (5,100 MT of sodium for each LAW Plant).

**d. Low-Activity Waste Feed Frequency, Phase 1.** The system shall be capable of mobilizing, staging, blending, qualifying, and delivering a batch of LAW feed to the vendor every 182 (TBR) days from sources where soluble salts must be dissolved and every 125 days (TBR) from sources consisting of supernatant.

Table 3-3. Low-Activity Waste Chemical Composition.

Chemical Analyte	Maximum ratio, analyte (mole) to sodium (mole)		
	Envelope A	Envelope B	Envelope C
Al	1.9 E-01	1.9 E-01	1.9 E-01
Ba	1.0 E-04	1.0 E-04	1.0 E-04
Ca	4.0 E-02	4.0 E-02	4.0 E-02
Cd	4.0 E-03	4.0 E-03	4.0 E-03
Cl	3.7 E-02	8.9 E-02	3.7 E-02
Cr	6.9 E-03	2.0 E-02	6.9 E-03
F	9.1 E-02	2.0 E-01	9.1 E-02
Fe	1.0 E-02	1.0 E-02	1.0 E-02
Hg	1.4 E-05	1.4 E-05	1.4 E-05
K	1.8 E-01	1.8 E-01	1.8 E-01
La	8.3 E-05	8.3 E-05	8.3 E-05
Ni	3.0 E-03	3.0 E-03	3.0 E-03
NO <sub>2</sub>	3.8 E-01	3.8 E-01	3.8 E-01
NO <sub>3</sub>	8.0 E-01	8.0 E-01	8.0 E-01
OH	7.0 E-01	7.0 E-01	7.0 E-01
Pb	6.8 E-04	6.8 E-04	6.8 E-04
PO <sub>4</sub>	3.8 E-02	1.3 E-01	3.8 E-02
SO <sub>4</sub>	9.7 E-03	7.0 E-02	2.0 E-02
TIC	3.0 E-01	3.0 E-01	3.0 E-01
TOC*	6.0 E-02	6.0 E-02	5.0 E-01
U	1.2 E-03	1.2 E-03	1.2 E-03

\*For each atom of carbon in total organic carbon.

Table 3-4. Low-Activity Waste Radionuclide Composition.

Radionuclide*	Maximum ratio, radionuclide (Bq) to sodium (mole)		
	Envelope A	Envelope B	Envelope C
TRU	4.8 E+05	4.8 E+05	3.0 E+06
<sup>137</sup> Cs	4.3 E+09	6.0 E+10	4.3 E+09
<sup>90</sup> Sr	4.4 E+07	4.4 E+07	8.0 E+08
<sup>99</sup> Tc	7.1 E+06	7.1 E+06	7.1 E+06

\*Some radionuclides, such as <sup>90</sup>Sr and <sup>137</sup>Cs, have daughters with relatively short half-lives. The daughters have not been listed in this table; however, they are present in concentrations associated with the normal decay chains of the radionuclides.

TRU = transuranic.

Table 3-5. Minimum and Maximum Order Quantities.  
(Each of two plants)

Envelope	Minimum order quantity (MT of sodium)	Maximum order quantity (MT of sodium)
A	2,600	4,900
B	100	1,000
C	100	2,900

MT = metric ton.

**3.2.1.3.1 Blend Low-Activity Waste in Low-Activity Waste Staging Tanks.** The system shall blend, pretreat, and qualify waste in the LAW staging tanks.

**a. Low-Activity Waste Staging Batch Size, Phase 1.** The system shall be capable of blending and qualifying batches of LAW feed with a volume of 1,040 m<sup>3</sup> (0.3 Mgal) (TBR) to 4,400 m<sup>3</sup> (1.16 Mgal). The system shall blend and qualify each batch of LAW feed in less than or equal to 113 days. (TBR)

**3.2.1.3.2 Transfer Low-Activity Waste Supernatants to Vendor Feed Storage.** The system shall transfer qualified LAW feed to a LAW or LAW/HLW Plant feed tank. The system shall be capable of transferring waste to both facilities but not at the same time.



**a. Low-Activity Waste Feed Batches, Phase 1.** The system shall be capable of delivering batches of Envelope A, B, and C LAW feed with a volume of 740 m<sup>3</sup> (0.2 Mgal) (TBR) to 3,820 m<sup>3</sup> (1 Mgal) to each plant feed tank in less than or equal to 9 days (TBR). Each batch shall contain at least 100 MT of sodium.

**b. Waste Pumpability.** The system shall satisfy the waste pumpability rules of WHC-SD-WM-OCD-015, Section 3.2.5, while transferring waste.

**3.2.1.4 Prepare High-Level Waste Feed for Phase 1 Treatment.** The system shall prepare and qualify waste as HLW feed and transfer it to the LAW/HLW plant.

**a. High-Level Waste Feed Composition.** The system shall deliver HLW feed satisfying the Envelope D feed limits in Tables 3-6, 3-7, and 3-8. Decay products such as radon from uranium and trace isotopes below  $1.0 \times 10^{-9}$  Ci/L and nonvolatile trace components below 0.001 g/L are not shown, but are allowed. NOTE: Waste composition limits are defined in terms of elemental or anion concentrations based on an overall waste concentration of 31 grams equivalent nonvolatile oxides/liter. Actual feed concentration of equivalent nonvolatile oxides may range from 25 g/L to 100 g/L.

**b. High-Level Waste Feed Physical Properties.** The system shall provide HLW feed within the physical property limits specified in Table 3-9.

**c. High-Level Waste Feed Production Quantities, Phase 1.** The system shall deliver at least 245 MT of waste oxides exclusive of sodium and silicon within 5 years after the beginning of plant operation and shall be capable of delivering a maximum of 465 MT of waste oxides exclusive of sodium and silicon within 9 years after the beginning of plant operation.

**d. High-Level Waste Feed Frequency, Phase 1.** The system shall be capable of delivering a batch of HLW feed to the vendor every 200 days. (TBR)

**3.2.1.4.1 Perform Enhanced Sludge Washing (In-tank).** The system shall adjust the concentration of selected components in a DST designated for sludge washing.

**a. Sludge Wash Batch Volume.** The system shall have the capability to wash an operator-selected quantity of insoluble waste in less than or equal to 214 days (TBR).

**b. High-Level Waste Sludge Washing Critical Component Ratios.** The system design goal is to optimize the pretreatment process, so that it provides the greatest benefit to DOE in terms of life-cycle cost minimization and contract compliance.

Table 3-6. High-Level Waste Feed Composition Limits for Nonvolatile Components.

Nonvolatile element	g/L		Nonvolatile element	g/L	
	Minimum	Maximum		Minimum	Maximum
Ag	NE	0.17	Np	NE	0.03
Al	1.3	4.3	P	NE	0.54
Am	NE	0.02	Pb	NE	0.34
As	NE	0.05	Pd	NE	0.04
B	NE	0.4	Pm	NE	0.03
Ba	NE	1.4	Pr	NE	0.11
Be	NE	0.02	Pu	NE	0.016
Bi	NE	0.86	Rb	NE	0.06
Ca	NE	2.2	Re	NE	0.03
Cd	NE	1.4	Rh	NE	0.04
Ce	NE	0.25	Ru	NE	0.11
Co	NE	0.14	S	NE	0.20
Cr	NE	0.21	Sb	NE	0.26
Cs	NE	0.18	Se	NE	0.16
Cu	NE	0.15	Si	NE	5.8
Dy	NE	0.008	Sm	NE	0.053
Eu	NE	0.005	Sn	NE	0.011
F	NE	1.1	Sr	NE	0.16
Fe	2.6	8.9	Ta	NE	0.008
Gd	NE	0.003	Tc	NE	0.08
Hg	NE	0.03	Te	NE	0.04
K	NE	0.41	Th	NE	0.16
La	NE	0.8	Ti	NE	0.4
Li	NE	0.043	Tl	NE	0.14
Mg	NE	0.65	U	NE	4.2
Mn	NE	2	V	NE	0.01
Mo	NE	0.2	W	NE	0.074
Na	2.3	6.0	Y	NE	0.05
Nb	NE	0.003	Zn	NE	0.13
Nd	NE	0.53	Zr	NE	4.6
Ni	0.05	0.73			

NE = not estimated.

Table 3-7. High-Level Waste Feed Composition Limits for Volatile Components.

Volatile components	g/L	
	Minimum	Maximum
Cl	0	0.1
CO <sub>3</sub>	0.74	9.3
NO <sub>2</sub> <sup>-</sup>	0	11.2 (total NO <sub>2</sub> <sup>-</sup> /NO <sub>3</sub> <sup>-</sup> ) as NO <sub>3</sub> <sup>-</sup>
NO <sub>3</sub> <sup>-</sup>	0	
TOC	0	3.4
CN	0	0.5
NH <sub>3</sub>	0	0.5

Specific critical component ratios to be targeted cannot be quantified at this time. They will be developed after information is received from the Privatization Contractors in their Phase 1A deliverables (e.g., technical reports) and the final Phase 1B contract. The critical component ratios will be established, and the pretreatment process can be optimized to approach the targeted compositions, while remaining within contractual requirements.

A number of candidate HLW feed components are outside Envelope D specifications. After pretreatment these components will be within the envelope, but a number of them are considered critical because they are expected to be near (within 20 percent) the minimum or maximum limit. These components include Ag, Al, Fe, Mn, Na, Ni, Pb, S, U, and Zr. In addition, some additional feed components are expected to be critical in producing HLW glass although their expected concentrations do not approach Envelope D limits. These components include B, Ca, Cr, K, Li, and Mg. Critical radionuclides including <sup>241</sup>Am, <sup>137</sup>Cs, <sup>60</sup>Co, <sup>154</sup>Eu, <sup>155</sup>Eu, <sup>239</sup>Pu, <sup>241</sup>Pu, <sup>106</sup>Ru, and <sup>90</sup>Sr will be critical because they will determine gamma and neutron dose rates for operations in the vitrification facility and for the product canisters.

**3.2.1.4.2 Transfer Sludge Wash Supernatants to East Double-Shell Tanks.** The system shall decant the supernatant following sludge washing and transfer it to a 200 East Area DST.

**a. Sludge Wash Supernatant Total Volume.** The system shall be capable of transferring at least 8,700 m<sup>3</sup> (2.3 Mgal) (TBR) of wash supernatant in 5 years (TBR).

**b. Sludge Wash Supernatant Batch Volume.** The system shall be capable of transferring 250 m<sup>3</sup> (0.07 Mgal) to 1,400 m<sup>3</sup> (0.37 Mgal) (TBR) of wash supernatant containing negligible insoluble solids in less than or equal to 4 days. (TBR)

**c. Waste Pumpability.** The system shall satisfy the waste pumpability rules of WHC-SD-WM-OCD-015, Section 3.2.5, while transferring waste.

Table 3-8. Maximum Radionuclide Composition of High-Level Waste Feed.

Isotope	Ci/L	Isotope	Ci/L	Isotope	Ci/L
<sup>3</sup> H	2 E-05	<sup>115m</sup> Cd	6.55 E-10	<sup>152</sup> Eu	1.5 E-04
<sup>14</sup> C	2 E-06	<sup>119m</sup> Sn	1.0 E-08	<sup>154</sup> Eu	1.6 E-02
<sup>55</sup> Fe	1.0 E-03	<sup>121m</sup> Sn	9.0 E-06	<sup>155</sup> Eu	9.0 E-03
<sup>59</sup> Ni	1.4 E-05	<sup>126</sup> Sn	4.8 E-05	<sup>234</sup> U	7.7 E-07
<sup>60</sup> Co	3.0 E-03	<sup>124</sup> Sb	2.61 E-09	<sup>235</sup> U	3.2 E-08
<sup>63</sup> Ni	1.6 E-03	<sup>126</sup> Sb	4.83 E-06	<sup>236</sup> U	8.2 E-08
<sup>79</sup> Se	4.2 E-07	<sup>126m</sup> Sb	3.43 E-05	<sup>238</sup> U	5.8 E-07
<sup>90</sup> Sr	3.1 E+00	<sup>125</sup> Sb	1.0 E-02	<sup>237</sup> Np	2.3 E-05
<sup>90</sup> Y	3.1 E+00	<sup>125m</sup> Te	3.0 E-03	<sup>238</sup> Pu	1.1 E-04
<sup>93m</sup> Nb	8.7 E-05	<sup>129</sup> I	9.0 E-08	<sup>239</sup> Pu	9.5 E-04
<sup>93</sup> Zr	1.4 E-04	<sup>134</sup> Cs	6.8 E-03	<sup>240</sup> Pu	2.6 E-04
<sup>99</sup> Tc	4.5 E-03	<sup>135</sup> Cs	3.0 E-05	<sup>241</sup> Pu	6.9 E-03
<sup>106</sup> Ru	2.0 E-04	<sup>137</sup> Cs	3.0 E+00	<sup>242</sup> Pu	7.1 E-08
<sup>106</sup> Rh	2.0 E-04	<sup>137m</sup> Ba	3.0 E+00	<sup>241</sup> Am	4.3 E-02
<sup>107</sup> Pd	4.0 E-06	<sup>144</sup> Ce	1.0 E-04	<sup>242</sup> Am	3.1 E-05
<sup>110m</sup> Ag	1.0 E-08	<sup>144</sup> Pr	1.0 E-04	<sup>242m</sup> Am	3.2 E-05
<sup>113m</sup> Cd	1.09 E-03	<sup>144m</sup> Pr	1.0 E-07	<sup>243</sup> Am	5.0 E-06
<sup>113m</sup> In	1.88 E-06	<sup>147</sup> Pm	1.6 E-01	<sup>242</sup> Cm	3.7 E-05
<sup>113</sup> Sn	1.88 E-06	<sup>151</sup> Sm	9.3 E-02	<sup>244</sup> Cm	9.3 E-04

**3.2.1.4.3 Prepare High-Level Waste Solids.** The system shall verify the completion of sludge washing and prepare washed solids for transfer to LAW/HLW Plant.

**a. High-Level Waste Feed Batch Sizes, Phase 1.** The system shall prepare batches of HLW feed 180 m<sup>3</sup> (0.05 Mgal) to 1,100 m<sup>3</sup> (0.3 Mgal) (TBR) in no more than 316 days. (TBR)

**b. High-Level Waste Feed Preparation, Phase 1.** The system shall prepare and qualify a batch of solids for transfer in 424 to 530 days. (TBR)

Table 3-9. High-Level Waste Feed Physical Properties.

Property	Design range
Total solids (wt%) dried at approximately 100°C	2.5-13
Total equivalent nonvolatile oxides (g/L)	25-100
Slurry density (g/mL)	1.02-1.10
Settled solids (vol%)	7-95
Apparent viscosity (cP at 25 °C)	
• at 10 s <sup>-1</sup> (50 rpm agitator)	6-94
• at 25 s <sup>-1</sup> (130 rpm agitator)	3-50
• at 183 s <sup>-1</sup>	1-50
Yield stress (dyne/cm <sup>2</sup> )	1-150
Settled solids shear strength after 2 days (dyne/cm <sup>2</sup> )	20-200
Heat capacity (cal/g- °C)	0.79-0.97
pH	>10

**3.2.1.4.4 Transfer High-Level Waste Sludge to Low-Activity Waste/High-Level Waste Plant.** The system shall transfer HLW feed from the sludge washing tank to the LAW/HLW Plant.

**a. High-Level Waste Feed Batch Transfer Volume.** The system shall be capable of transferring batches of HLW feed with a volume of 264 m<sup>3</sup> (0.07 Mgal) (TBR) to 538 m<sup>3</sup> (0.14 Mgal) (TBR) to the vendor in less than or equal to 1 day (TBR). The initial batch of HLW feed shall contain at least 5 MT of waste oxides exclusive of sodium and silicon. The oxide content of additional batches will be operator-selected.

**b. Waste Pumpability.** The system shall satisfy the waste pumpability rules of WHC-SD-WM-OCD-015, Section 3.2.5, while transferring waste.

**3.2.1.5 Sample Double-Shell Tank Waste.** The system shall obtain samples of tank waste and deliver them to a laboratory for analysis.

**a. Double-Shell Tank System Waste Sampling Requirements.** Samples shall enable determination of composition for elements and compounds listed in Tables 3-3, 3-4, 3-6, 3-7, and 3-8, and for physical properties listed in Table 3-9.

**3.2.1.6 Distribute Utilities in Double-Shell Tank System.** The system shall distribute electricity, raw/service water, and potable water to the DST System.

**3.2.1.7 Support Double-Shell Tank System.** The system shall provide logistic support and problem resolution for the DST System during system operations. These activities include resolution of safety issues; resolution of operational failures; system maintenance; supply support; operational and maintenance training; support infrastructure maintenance; equipment storage, packaging, and transportation; equipment/clothing decontamination; storage/disposal of items consumed during operation; and other system-management activities.

**3.2.2 Reserved.**

### 3.2.3 External Interface Requirements

**3.2.3.1 External Waste Generators Using Surface Transport.** The system shall accept new liquid waste transported by truck or rail car from on-site external waste generators (e.g., S Plant; T Plant; and the 100, 300, and 400 Areas) at the 204-AR waste unloading facility.

**a. 204-AR Waste Receipt Properties.** The system shall accept waste with the properties shown in Table 3-10 at the 204-AR unloading facility.

Table 3-10. 204-AR Vault Waste Composition Requirements for Receipt.

Variable	Specification limit
1. pH	$7 < \text{pH} < 14$ ( $10^{-7}M < \text{OH}^- < 0.1M$ ) $\text{pH} \geq 5$ , if Chloride $< 0.01M$
2. Chloride (rail tank car)	$< 0.01M$
3. Chloride (tank trailer)	$< 0.035M$
4. HCL-based chemicals	No hydrochloric acid-based chemicals shall be allowed
5. Fissile material	$< 0.01$ g/gal

**3.2.3.2 Plutonium Finishing Plant (PFP).** The system shall accept new liquid waste from the PFP.

**a. Plutonium Finishing Plant Waste Annual Volume.** The system shall accept up to  $30 \text{ m}^3$  (8,000 gal) (TBR) of liquid waste per year from the PFP.

**b. Plutonium Finishing Plant Waste Properties.** The system shall accept waste with properties satisfying the requirements of the following documents:

- WHC-SD-WM-EV-053
- HNF-2288, Sections E, F, and G
- HNF-SD-WM-DQO-001
- WHC-SD-WM-OCD-015
- HNF-SD-WM-TSR-006, AC 5.7, 5.8, and 5.12 (AB).

**3.2.3.3 S Plant.** The system shall accept new liquid waste from S Plant.

**a. S Plant Waste Volume.** The system shall accept up to 235 m<sup>3</sup> (62,000 gal) (TBR) of liquid waste per year from S Plant.

**b. S Plant Waste Properties.** The system shall accept waste with properties satisfying the requirement of the following documents:

- WHC-SD-WM-EV-053
- HNF-2288, Sections E, F, and G
- HNF-SD-WM-DQO-001
- WHC-SD-WM-OCD-015
- HNF-SD-WM-TSR-006, AC 5.7, 5.8, and 5.12 (AB).

**3.2.3.4 B Plant/Waste Encapsulation and Storage Facility (WESF).** The system shall accept new liquid waste from B Plant/WESF.

**a. B Plant/Waste Encapsulation and Storage Facility Waste Volume.** The system shall accept up to 204 m<sup>3</sup> (0.054 Mgal) (TBR) of liquid waste per year from B Plant/WESF.

**b. B Plant/Waste Encapsulation and Storage Facility Waste Properties.** The system shall accept waste with properties satisfying the requirement of the following documents:

- WHC-SD-WM-EV-053
- HNF-2288, Sections E, F, and G
- HNF-SD-WM-DQO-001
- WHC-SD-WM-OCD-015
- HNF-SD-WM-TSR-006, AC 5.7, 5.8, and 5.12 (AB).

**3.2.3.5 Single-Shell Tank System.** The system shall accept waste from the SST system.

**a. West Single-Shell Tank Salt Well Liquid Waste Volume.** The DST System shall be capable of accepting at least 9500 m<sup>3</sup> (2.5 Mgal) (TBR) of dilute, noncomplexed (DN) liquors

and 3,400 m<sup>3</sup> (0.9 Mgal) of dilute, complexed (DC) liquors from salt well pumping from the SSTs over 4 years.

**b. East Single-Shell Tank Salt Well Liquid Waste Volume.** The DST System shall be capable of accepting at least 800 m<sup>3</sup> (0.2 Mgal) of DN and 3400 m<sup>3</sup> (0.9 Mgal) (TBR) of DC liquors from salt well pumping from the SSTs over 4 years.

**c. Single-Shell Tank Salt Well Liquid Waste Properties.** The system shall accept SST waste with properties satisfying the requirements specified in the following documents:

- WHC-SD-WM-EV-053
- HNF-2288, Sections E, F, and G
- HNF-SD-WM-DQO-001
- WHC-SD-WM-OCD-015
- HNF-SD-WM-TSR-006, AC 5.7, 5.8, and 5.12 (AB).

**d. Single-Shell Tank Waste Retrieval Volume, Phase 1.** Beginning in fiscal year 2003, the system shall be capable of accepting at least 29,500 m<sup>3</sup> (7.8 Mgal) (TBR) of SST waste through the end of Phase 1.

**3.2.3.6 Evaporator.** The system shall accept waste from the evaporator.

**a. Concentrated Waste Receipt Rate.** The system shall be capable of continuously receiving evaporator slurry at a nominal 0.00189 m<sup>3</sup>/s (30 gpm) to 0.00442 m<sup>3</sup>/s (70 gpm) for 2 months.

**b. Concentrated Waste Composition.** The system shall accept waste with radionuclide concentrations no greater than those listed in Table 3-11 (AB).

**c. Emergency Transfer Volume from Evaporator.** The system shall be capable of accepting an emergency transfer of less than or equal to 98 m<sup>3</sup> (26 kgal) (AB) of waste satisfying the requirements of Table 3-11 in 8 minutes.

**3.2.3.7 Phase 1 Low-Activity Waste Plant.** The system shall accept entrained solids, <sup>99</sup>Tc, and <sup>90</sup>Sr/TRU product from the LAW treatment system.

**a. Low-Activity Waste Plant Entrained Solids Total Volume.** The system shall accept the same quantity of entrained solids and <sup>90</sup>Sr/TRU waste products from the LAW treatment system as were delivered. The entrained solids and <sup>90</sup>Sr/TRU may be mixed before return to the DST System.



Table 3-11. Maximum Radionuclide Concentrations after Evaporation.

Radionuclide	Slurry product concentration ( $\mu\text{Ci/mL}$ )	Radionuclide	Slurry product concentration ( $\mu\text{Ci/mL}$ )
	Bounding source strength		Bounding source strength
$^{14}\text{C}$	2.6 E-01	$^{155}\text{Eu}$	7.0 E+00
$^{60}\text{Co}$	1.2 E+00	$^{226}\text{Ra}$	3.3 E-02
$^{79}\text{Se}$	7.8 E-02	$^{234}\text{U}$	1.1 E-04
$^{90}\text{Sr}$	2.2 E+02	$^{235}\text{U}$	4.8 E-06
$^{94}\text{Nb}$	9.8 E-02	$^{238}\text{U}$	2.7 E-05
$^{99}\text{Tc}$	2.0 E+00	$^{237}\text{Np}$	1.1 E-03
$^{106}\text{Ru}$	5.3 E+01	$^{238}\text{Pu}$	1.3 E-03
$^{129}\text{I}$	2.6 E-03	$^{239/240}\text{Pu}$	1.6 E-01
$^{134}\text{Cs}$	1.5 E+01	$^{241}\text{Pu}$	1.5 E+01
$^{137}\text{Cs}$	1.5 E+03	$^{241}\text{Am}$	1.0 E+00
$^{144}\text{Ce}$	8.5 E-01	$^{244}\text{Cm}$	1.3 E-02
$^{154}\text{Eu}$	5.0 E+00		

**b. Entrained Solids Batch Volume Requirements.** The system shall be capable of accepting entrained solids that meet all of the following criteria:

- >20 vol% solids,
- >50% of the solids content at which the slurry viscosity is 30 cP, and
- >50% of the solids content at which the slurry specific gravity is 1.5.

**c. Entrained Solids Physical Properties.** The system shall accept waste products that meet the requirements shown in Table 3-12.

**d. Waste Product Sodium Content.** The system shall accept entrained solids and  $^{90}\text{Sr}/\text{TRU}$  waste products with less than or equal to 60 g of sodium per kilogram of insoluble solids, measured on a dry solids basis.

Table 3-12. Physical Requirements for Liquids or Slurries Transferred to U.S. Department of Energy.

Properties	Values
Specific gravity <sup>a</sup>	1.0 to 1.5
Viscosity <sup>a</sup>	1.0 to 30.0 cP
Solids content <sup>a,b</sup>	<30% (volume of bed)
pH range	>11.0
Operating temperature (waste)	26.6 °C to 82.2 °C
Particles size greater than 4,000 µm	0% w/w
Particles size between 500 and 4,000 µm	<1% w/w
Particles size between 50 and 500 µm	<5% w/w
Miller number of slurry at transfer temperature and concentration (ASTM G75-95)	<100

ASTM G75-95, *Standard Test Method for G75-95 Determination of Slurry Abrasivity (Miller Number) and Slurry Abrasion Response of Materials (SAR Number)*, American Society for Testing and Materials, West Conshohocken, Pennsylvania.

<sup>a</sup> Measured at minimum planned transfer temperature. Maximum temperature drop during transfer is 11 °C.

<sup>b</sup> Value reported is the percent of slurry volume represented by the settled bed of solids.

**e. Entrained Solids Cesium-137 Content.** The system shall accept entrained solids with a total quantity of soluble <sup>137</sup>Cs in the entrained solids product, and the soluble plus insoluble <sup>137</sup>Cs in the <sup>90</sup>Sr/TRU product is less than or equal to 5 percent of the total <sup>137</sup>Cs provided by in the LAW feed.

**f. Entrained Solids Technetium-99 Content.** The system shall accept entrained solids with a total quantity of soluble <sup>99</sup>Tc in the entrained solids product and soluble plus insoluble <sup>99</sup>Tc in the <sup>90</sup>Sr/TRU product is less than or equal to 5 percent of the total <sup>99</sup>Tc provided in the LAW feed.

**g. Plutonium Content.** The system shall accept waste products with a plutonium concentration less than or equal to 0.05 g/gal and a mass less than or equal to 200 g plutonium in a single transfer.

**h. Separable Organics.** The system shall not accept waste products that will develop a separable organic phase during prolonged storage.

i. **Scaling.** The system shall not accept waste products that will deposit scale on the pipe walls.

j. **Stability Prevention of Exothermic Reaction.** The system shall not accept waste products that have the potential for an exothermic reaction.

k. **Immobilized High-Level Waste Impacts.** The system shall accept waste products that do not affect the calculated immobilized HLW product quantity and the following two limitations.

- **Limitation 1.** For each metric ton of sodium in the LAW feed, the treatment process has not added and/or precipitated at least 10 kg of material in total into the intermediate waste products (on an equivalent oxide basis excluding silicon and sodium), including entrained solids,  $^{90}\text{Sr}$  and TRU, and  $^{99}\text{Tc}$ .
- **Limitation 2.** For each metric ton of sodium in the LAW feed, the treatment process has not added at least 100 g of sulfur, phosphorous, fluorine, chlorine, and chromium in total to the intermediate waste products (on an equivalent oxide basis if applicable), including entrained solids,  $^{137}\text{Cs}$ ,  $^{90}\text{Sr}$ /TRU, and  $^{99}\text{Tc}$ .

l. **Waste Pumpability.** Waste received from the LAW Plant shall satisfy the waste pumpability rules of WHC-SD-WM-OCD-015, Section 3.2.5 and OSD-T-151-00007, Section 7.2.1.

**3.2.3.8 Phase 1 Low-Activity Waste/High-Level Waste Plant.** The system shall accept intermediate waste products from the LAW/HLW treatment system.

a. **Entrained Solids Total Volume.** The system shall be capable of accepting the same quantity of entrained solids from the LAW/HLW treatment system as were delivered. The system shall not accept  $^{99}\text{Tc}$  and  $^{90}\text{Sr}$ /TRU intermediate waste products.

b. **Entrained Solids Properties.** The system shall be capable of accepting entrained solids that satisfy Requirements 3.2.3.7.b through l from the LAW/HLW treatment system; however, the system shall not accept  $^{99}\text{Tc}$  and  $^{90}\text{Sr}$ /TRU intermediate waste products.

**3.2.3.9 Central Plateau Electrical System.** The system shall obtain electricity from the Central Plateau Electrical System and distribute it throughout the DST System.

a. **Electrical Power.** Reserved. No requirements have been identified to date.

**3.2.3.10 Central Plateau Water System.** The system shall obtain water from the Central Plateau Water System and distribute it throughout the DST System.

**a. Water—Phase 1.** The system shall be capable of distributing 49,000 m<sup>3</sup> (13 Mgal) (TBR) of water from Hanford Landlord System for waste processing throughout the DST System.

### 3.2.4 Physical Characteristics

Not applicable.

### 3.2.5 System Quality Factors

**3.2.5.1 Reliability, Availability, Maintainability.** The integrated schedule risk associated with reliability, availability, and maintainability of the total hardware and operating and maintenance system used to accomplish preparation and transfer of feed batches shall not exceed 2 days per batch. (TBR)

#### 3.2.5.2 Additional Quality Factors.

**3.2.5.2.1 Design Life.** The DST System shall be designed to be operable through 2028. The DST System shall be designed to provide containment through 2040.

### 3.2.6 Environmental Conditions

The system shall be designed to operate during exposure to the following natural and induced environments.

**3.2.6.1 Environmental Conditions.** The system shall be designed for the natural environmental conditions specified in WHC-SD-GN-ER-501, and to withstand the wind, lightning, earthquake, ashfall, and combination loads per HNF-PRO-097. HNF-PRO-097 will take precedence over WHC-SD-GN-ER-501, if conflicts occur.

**3.2.6.2 Chemical.** Equipment installed in the tanks shall be designed to perform their intended function in the chemical environment of the tanks. This environment and its context, for DSTs, is described in HNF-SD-WM-SP-012, Appendix C.

**3.2.6.3 Radiation.** Equipment installed in the tanks shall be designed to perform their intended function in the radiological environments specified in HNF-2004.

### **3.2.7 Transportability**

Assemblies and components shall be designed to be handled, packaged, marked, and transported in accordance with HNF-PRO-157.

### **3.2.8 Flexibility and Expansion**

The system shall comply with the flexibility and expansion requirements of DOE Order 6430.1A, Division 1.

### **3.2.9 Portability**

Not applicable.

## **3.3 DESIGN AND CONSTRUCTION**

The system design shall follow the general design guidelines provided by DOE Order 6430.1A.

### **3.3.1 Materials, Processes, and Design Practices**

**3.3.1.1 Toxic Products and Formulations.** The system shall comply with the requirements of HNF-PRO-451, *Regulated Substance Management*.

**3.3.1.2 Dangerous Waste.** The system shall incorporate dangerous waste storage and treatment design features that comply with the requirements of WAC 173-303.

**3.3.1.3 Decontamination and Decommissioning.** The system shall be designed for ease of decontamination during operation and for decommissioning at the end of system life in accordance with DOE Order 6430.1A, Sections 0110-99.0.1, 0205-2, and 1300-11.

### **3.3.2 Electromagnetic Radiation**

The system shall comply with electromagnetic radiation emission requirements set forth in 47 CFR 15, Subpart B (TBR).

### **3.3.3 Nameplates and Product Markings**

The system nameplates and marking shall comply with the requirements of DOE Order 6430.1A, Section 1300-12.4.11.

### **3.3.4 Workmanship**

Not applicable at the system level.

### **3.3.5 Interchangeability**

The design shall enable interchangeability of parts between components of the same function regardless of manufacturer to the extent both practicable and cost-effective.

### **3.3.6 Safety**

The system shall be designed to incorporate safety requirements as specified below. The requirements of this section shall be interpreted in the context of the BIO.

Note: Some requirements specified below are operational requirements from HNF-SD-WM-BIO-001 (AB). The HNF-SD-WM-BIO-001 requirements in this specification may be replaced in future revisions with requirements from engineering basis documents.

#### **3.3.6.1 Personnel Safety.**

**3.3.6.1.1 Occupational Radiological Protection.** The system shall be designed to protect workers from occupational radiation exposures in accordance with the requirements contained in HSRCM-1.

**3.3.6.1.2 Occupational Safety and Health Administration (OSHA) Standards.** The system shall incorporate occupational safety and health design features that comply with the requirements of WHC-SD-WM-HSP-002.

#### **3.3.6.2 System Safety.**

**3.3.6.2.1 Corrosion Prevention and Control.** The system shall incorporate corrosion prevention and control features in accordance with WAC 173-303-640(3).

**3.3.6.2.2 Waste Composition.** The system shall maintain waste stored in the DSTs within the waste composition limits specified in Table 3-13.

Table 3-13. Double-Shell Tank Waste Storage Composition Requirements.

Temp.	Nitrate concentration	Variable	Limits
$\leq 212^\circ\text{F}$	$[\text{NO}_3^-] \leq 1.0M$	$[\text{OH}^-]$	$0.010M \leq [\text{OH}^-] \leq 5.0M$ ( $\leq 8.0M$ if $< 167^\circ\text{F}$ )
		$[\text{NO}_2^-]$	$0.011M \leq [\text{NO}_2^-] \leq 5.5M$
		$[\text{NO}_3^-]/([\text{OH}^-] + [\text{NO}_2^-])$	$< 2.5$
	$1.0M < [\text{NO}_3^-] \leq 3.0M$	$[\text{OH}^-]$	$0.1 [\text{NO}_3^-] \leq [\text{OH}^-] < 10M$
		$[\text{OH}^-] + [\text{NO}_2^-]$	$\geq 0.4 [\text{NO}_3^-]$
	$[\text{NO}_3^-] > 3.0M$	$[\text{OH}^-]$	$0.3M \leq [\text{OH}^-] < 10M$
$[\text{OH}^-] + [\text{NO}_2^-]$		$\geq 1.2M$	
$[\text{NO}_3^-]$		$\leq 5.5M$	
$\geq 212^\circ\text{F}$	Same as above except $\text{OH}^- < 4M$		

**3.3.6.2.3 Tank Temperature Limits.** The system shall maintain waste temperatures in each DST in accordance with HNF-SD-WM-TSR-006, *Tank Waste Remediation System Technical Safety Requirements*, Section 2.1.1 (AB).

**3.3.6.2.4 Dome Vault Loading.** To prevent structural damage to tank domes, the static dome loading shall meet the requirements of HNF-SD-WM-TSR-006, Section 5.16 (AB).

### 3.3.6.3 Environmental Safety.

**3.3.6.3.1 Secondary Containment and Leak Detection.** The system shall incorporate secondary containment and leak-detection design features in accordance with 40 CFR 264.193 and 40 CFR 265.193; WAC 173-360 (for underground petroleum storage tanks only); and WAC 173-303-640(4).

**3.3.6.3.2 Spill Prevention and Controls.** The system shall incorporate spill prevention and control design features in accordance with 40 CFR 264.194 and 40 CFR 265.194; WAC 173-303-630(7) and WAC 173-303-640(5). In the event of a conflict, the most stringent requirement shall take precedence.

**3.3.6.3.3 Nonradioactive Airborne Emissions.** The system shall incorporate design features that limit the combined nonradioactive ambient airborne emissions from all TWRS major facilities such that compliance with WHC-CM-7-5, Section 2, is achieved. Also, other

Hanford Site major facilities nonradioactive airborne emissions shall be considered when designing the system to be compliant with the above requirements.

**3.3.6.3.4 Radioactive Airborne Emissions.** The system shall incorporate design features that limit the combined radioactive ambient airborne emissions from all TWRS major facilities such that compliance with WHC-CM-7-5, Section 2, is achieved. Also, other Hanford Site major facilities radioactive airborne emissions shall be considered when designing the system to be compliant with the above requirements.

**3.3.6.3.5 Monitoring of Liquid Effluent Discharges to the Environment.** The system shall be designed to comply with the groundwater-monitoring requirements contained in WAC 173-200, WAC 173-201A, and WAC 173-240.

**3.3.6.3.6 Radiation Protection of the Public and Environment.** The system shall be designed in accordance with the radiation release limits specified in HNF-PRO-451, HNF-PRO-452, and HNF-PRO-455.

**3.3.6.3.7 Flammable Gas Design Requirements.** The system shall meet flammable gas ignition control sets in accordance with HNF-SD-WM-TSR-006, AC 5.9, 5.10, and 5.11 (AB).

### **3.3.7 Human Engineering**

System design shall comply with Section 1300-12, "Human Factors Engineering," of DOE Order 6430.1A.

### **3.3.8 Nuclear Safety**

**3.3.8.1 Criticality Safety.** The system shall be designed in accordance with the nuclear criticality safety requirements of HNF-PRO-334 and HNF-PRO-537 through HNF-PRO-550.

**3.3.8.2 Nuclear Safety Classification.** The subsystem and components shall be designed in accordance with the safety classification for each. The safety classification shall be determined using the process described in HNF-PRO-700, -701, -702, -703, and -704 based on the guidelines in HNF-SD-WM-BIO-001, Tables 5.3-2 and 5.3-3 (AB).

### **3.3.9 System Security**

#### **3.3.9.1 General System and Information Security.**

The system shall be designed in accordance with HNF-PRO-394.



**3.3.9.2 Radiation Area Security.** The system shall be designed such that access controls to areas of high radiation meet the requirements of the *Hanford Site Radiological Control Manual* (HSRCM-1, Chapter 2).

**3.3.10 Government-Furnished Property Usage.**

This section is not applicable to this specification.

**3.3.11 Computer Resource Reserve Capacity**

Not applicable at the system level.

**3.4 DOCUMENTATION**

Records, documents, and table control pertinent to design functions shall be in accordance with HNF-PRO-222 and HNF-PRO-224. Drafting standards for drawings shall be in accordance with HNF-PRO-242.

**3.5 LOGISTICS**

**3.5.1 Maintenance and Operation**

Remote, limited, or contact maintenance requirements shall be implemented with current regulatory requirements, policies, and procedures and incorporate a layer of principles. Operation should be remote to minimize exposure and contamination.

**3.5.1.1 Calibration.** Systems shall be designed to allow periodic calibration. Calibration cycles, methods, and equipment shall be established based on manufacturer's instruction, component and system reliability, environmental conditions, and site-specific historical data.

**3.5.2 Transportation of Hazardous Materials**

Subsystems used to ship hazardous materials shall be designed to comply with the requirements of HNF-PRO-154 through HNF-PRO-163.

### **3.5.3 Solid Waste**

**3.5.3.1 Solid Waste Acceptance Criteria.** Wastes generated as a result of system operations and maintenance shall be disposed of in accordance with HNF-PRO-455, *Solid Waste Management*.

## **3.6 PERSONNEL AND TRAINING**

The system shall be designed such that it can be operated by personnel possessing qualifications in accordance with HNF-PRO-057, HNF-PRO-153, and HNF-SD-WM-TR-026.

## **3.7 CHARACTERISTICS OF SUBELEMENTS**

The elements below are the major DST System elements necessary for Phase 1 DST System operation.

### **3.7.1 Double-Shell Tank Farms**

This element is composed of all double-shelled containment systems used to store existing waste, store intermediate products returned by the privatization contractors, and provide containment of waste to meet the privatization waste feed envelopes. Existing items allocated to this element include the DST tank farms (241-SY, AN, AW, AP, AY, AZ), ventilation systems, and farm-specific instrumentation, and control systems. This element will perform DST waste storage functions.

### **3.7.2 Transfer System**

This element is composed of all items required to transfer tank contents from one tank structure to another. This element will perform the transfer functions. All items of the existing transfer system that satisfy system requirements are allocated to this element. This element is composed of items such as decant pumps, slurry pumps, piping networks, slurry distributors, active MUSTs (including associated ventilation) and master pump shutdown system.

### **3.7.3 Waste Preparation Equipment**

This element consists of items required to prepare the waste for transfer. This element will transform tank wastes into a form that can be transferred using the transfer system. The composition of this element, based on existing AGAs (HNF-SD-TWR-AGA-001), includes

mixer pumps, chemical storage and mixing tanks, and associated chemical addition pumps and piping.

#### **3.7.4 Double-Shell Tank Master Monitor and Control System**

This element consists of all items required to monitor and control DST functions during Phase 1. This element is composed of items such as the Tank Monitor and Control System.

#### **3.7.5 Double-Shell Tank Utility Distribution System**

This element provides power and water from site utilities to the DST System elements. The site interface needs to be determined.

#### **3.7.6 Double-Shell Tank Maintenance and Recovery Systems**

This is a collection of systems that enable DST System maintenance and recovery from abnormal circumstances (e.g., plugged lines, leaking waste into secondary containment). These systems will be derived from the O&M concept.

### **3.8 PRECEDENCE**

The hierarchical relationship among requirements specified in Section 3 is as follows, excepting those instances where Washington State has been granted regulatory authority by the U.S. Government:

- Federal laws (e.g., CFRs)
- Revised Code of Washington as specified in WACs
- Local ordinances
- DOE orders
- Project Hanford Management Contractor procedures
- National Consensus Codes and Standards.

### **3.9 QUALIFICATION**

The system design shall be verified to HNF-PRO-445.

**3.10 STANDARD SAMPLE**

Not applicable to this specification.

**3.11 PREPRODUCTION STANDARD**

Not applicable to this specification.

HNF-SD-WM-TRD-007  
Revision D

This page intentionally left blank.

## **4.0 QUALITY ASSURANCE PROVISIONS**

Quality assurance for the DST System shall be performed in accordance with HNF-MP-599. Inspections, as defined in Section 4.3, shall be conducted during the design and development of the system to provide assurance of compliance with the requirements of this specification.

### **4.1 RESPONSIBILITY FOR INSPECTIONS**

The design contractor shall be responsible for the performance and documentation of all inspections for each system developed in accordance with this system specification. Inspections shall be conducted at the contractor facilities or the facilities of the contractor's choice with the approval of the procuring authority. The procuring authority reserves the right to witness or perform the specified inspections.

### **4.2 SPECIAL TESTS AND EXAMINATIONS**

Not applicable.

### **4.3 QUALITY CONFORMANCE INSPECTIONS**

Qualification shall be performed on system hardware representative of the approved production design. Qualification of the system to ensure compliance with the requirements of Section 3 shall be by examination, demonstration, test, and/or analysis, as defined in Table 4-1. All the inspections indicated in Table 4-1 are preliminary and to be refined.

a. Examination is an element of inspection consisting of investigation without the use of special laboratory appliances or procedures to determine compliance with requirements.

b. Demonstration is an element of inspection that is limited to readily observable functional operation to determine compliance with requirements. This element of inspection does not require the use of special equipment or sophisticated instrumentation.

c. Test is an element of inspection that employs technical means including (but not limited to) the evaluation of functional characteristics by use of special equipment or instrumentation, simulation techniques, and the application of established principles and procedures to determine compliance with requirements. The analysis of data derived from testing is an integral part of this inspection.

d. Analysis is an element of inspection consisting of processing accumulated results and conclusions to provide proof that verification of a requirement(s) has been accomplished. The analytical results may be comprised of a compilation of interpretations of existing information or derived from lower-level examinations, tests, demonstrations, or analyses.

Table 4-1. Double-Shell Tank System Quality Conformance Inspection Matrix. (8 Sheets)

Paragraph Number	Title	Inspection Element				
		Exam	Demo	Test	Anly	N/A
3.2.1.1.a	Double-Shell Tank System Storage Capacity, Phase 1				X	
3.2.1.1.b	Double-Shell Tank System Spare Storage Capacity				X	
3.2.1.1.1.a	West Double-Shell Tank System Storage Capacity, Phase 1				X	
3.2.1.1.2.a	East Double-Shell Tank System Storage Capacity, Phase 1				X	
3.2.1.1.3.a	204-AR Annual Capacity				X	
3.2.1.1.3.b	204-AR Batch Transfer				X	
3.2.1.1.3.c	204-AR Transferred Waste Properties				X	
3.2.1.1.4.a	West Area Liquid Waste Annual Capacity				X	
3.2.1.1.4.b	Waste Batch Size—West Area				X	
3.2.1.1.5.a	East Area Liquid Waste Annual Capacity				X	
3.2.1.1.5.b	Waste Batch Size—East Area				X	
3.2.1.1.6.a	Annual Volume of Concentrated Waste				X	
3.2.1.1.6.b	Concentrated Waste Receipt Rate				X	
3.2.1.1.7.a	Evaporator Purge Batch Size				X	
3.2.1.1.8.a	Treatment Plant Waste Product Volume, Phase 1				X	
3.2.1.1.8.b	Treatment Plant Waste Receipt Requirements				X	
3.2.1.2.a	Low-Activity Waste Staging Quantity, Phase 1				X	



Table 4-1. Double-Shell Tank System Quality Conformance Inspection Matrix. (8 Sheets)

Paragraph Number	Title	Inspection Element				
		Exam	Demo	Test	Anly	N/A
3.2.1.2.b	Space Management Annual Waste Volume, Phase 1				X	
3.2.1.2.c	Evaporator Feed Volume, Phase 1				X	
3.2.1.2.d	Unretrieved Waste Properties			X	X	
3.2.1.2.1.a	Supernatant Preparation—West Area				X	
3.2.1.2.1.b	Soluble Waste Preparation—West Area			X	X	
3.2.1.2.1.c	Insoluble Waste Preparation—West Area			X	X	
3.2.1.2.2.a	200 West Area Waste Batch Transfer				X	
3.2.1.2.2.b	Waste Pumpability				X	
3.2.1.2.3.a	Cross-Site Waste Transfer Volume				X	
3.2.1.2.3.b	Waste Pumpability				X	
3.2.1.2.4.a	Supernatant Preparation—East Area				X	
3.2.1.2.4.b	Soluble Waste Preparation—East Area			X	X	
3.2.1.2.4.c	Insoluble Waste Preparation—East Area			X	X	
3.2.1.2.5.a	200 East Area Waste Batch Transfer				X	
3.2.1.2.5.b	Waste Pumpability				X	
3.2.1.2.6.a	Evaporator Feed Annual Volume				X	
3.2.1.2.6.b	Evaporator Feed Rate				X	
3.2.1.2.6.c	Evaporator Feed Requirements				X	

Table 4-1. Double-Shell Tank System Quality Conformance Inspection Matrix. (8 Sheets)

Paragraph Number	Title	Inspection Element				
		Exam	Demo	Test	Anly	N/A
3.2.1.2.6.d	Waste Pumpability				X	
3.2.1.2.7.a	Low-Activity Waste Staging Batch Volumes				X	
3.2.1.2.7.b	Waste Pumpability				X	
3.2.1.3.a	Low-Activity Waste Feed Composition and Physical Properties, Phase 1				X	
3.2.1.3.b	Waste Compatibility				X	
3.2.1.3.c	Low-Activity Waste Feed Production Quantities, Phase 1				X	
3.2.1.3.d	Low-Activity Waste Feed Frequency, Phase 1				X	
3.2.1.3.1.a	Low-Activity Waste Staging Batch Size, Phase 1				X	
3.2.1.3.2.a	Low-Activity Waste Feed Batches, Phase 1				X	
3.2.1.3.2.b	Waste Pumpability				X	
3.2.1.4.a	High-Level Waste Feed Composition				X	
3.2.1.4.b	High-Level Waste Feed Physical Properties				X	
3.2.1.4.c	High-Level Waste Feed Production Quantities, Phase 1				X	
3.2.1.4.d	High-Level Waste Feed Frequency, Phase 1				X	
3.2.1.4.1.a	Sludge Wash Batch Volume				X	
3.2.1.4.1.b	High-Level Waste Sludge Washing Critical Component Ratios					X

55

Revision D

Table 4-1. Double-Shell Tank System Quality Conformance Inspection Matrix. (8 Sheets)

Paragraph Number	Title	Inspection Element				
		Exam	Demo	Test	Anly	N/A
3.2.1.4.2.a	Sludge Wash Supernatant Total Volume				X	
3.2.1.4.2.b	Sludge Wash Supernatant Batch Volume				X	
3.2.1.4.2.c	Waste Pumpability				X	
3.2.1.4.3.a	High-Level Waste Feed Batch Sizes, Phase 1			X	X	
3.2.1.4.3.b	High-Level Waste Feed Preparation, Phase 1			X	X	
3.2.1.4.4.a	High-Level Waste Feed Batch Transfer Volume				X	
3.2.1.4.4.b	Waste Pumpability				X	
3.2.1.5.a	Double-Shell Tank System Waste Sampling Requirements					X
3.2.3.1.a	204-AR Waste Receipt Properties				X	
3.2.3.2.a	Plutonium Finishing Plant Waste Annual Volume				X	
3.2.3.2.b	Plutonium Finishing Plant Waste Properties				X	
3.2.3.3.a	S Plant Waste Volume				X	
3.2.3.3.b	S Plant Waste Properties				X	
3.2.3.4.a	B Plant/Waste Encapsulation and Storage Facility Waste Volume				X	
3.2.3.4.b	B Plant/Waste Encapsulation and Storage Facility Waste Properties				X	
3.2.3.5.a	West Single-Shell Tank Salt Well Liquid Waste Volume				X	

Table 4-1. Double-Shell Tank System Quality Conformance Inspection Matrix. (8 Sheets)

Paragraph Number	Title	Inspection Element				
		Exam	Demo	Test	Anly	N/A
3.2.3.5.b	East Single-Shell Tank Salt Well Liquid Waste Volume				X	
3.2.3.5.c	Single-Shell Tank Salt Well Liquid Waste Properties				X	
3.2.3.5.d	Single-Shell Tank Waste Retrieval Volume, Phase 1				X	
3.2.3.6.a	Concentrated Waste Receipt Rate				X	
3.2.3.6.b	Concentrated Waste Composition				X	
3.2.3.6.c	Emergency Transfer Volume from Evaporator				X	
3.2.3.7.a	Low-Activity Waste Plant Entrained Solids Total Volume				X	
3.2.3.7.b	Entrained Solids Batch Volume Requirements				X	
3.2.3.7.c	Entrained Solids Physical Properties				X	
3.2.3.7.d	Waste Product Sodium Content				X	
3.2.3.7.e	Entrained Solids Cesium-137 Content				X	
3.2.3.7.f	Entrained Solids Technetium-99 Content				X	
3.2.3.7.g	Plutonium Content				X	
3.2.3.7.h	Separable Organics				X	
3.2.3.7.i	Scaling				X	
3.2.3.7.j	Stability Prevention of Exothermic Reaction				X	
3.2.3.7.k	Immobilized High-Level Waste Impacts				X	
3.2.3.7.l	Waste Pumpability				X	

Table 4-1. Double-Shell Tank System Quality Conformance Inspection Matrix. (8 Sheets)

Paragraph Number	Title	Inspection Element				
		Exam	Demo	Test	Anly	N/A
3.2.3.8.a	Entrained Solids Total Volume				X	
3.2.3.8.b	Entrained Solids Properties				X	
3.2.3.9.a	Electrical Power				X	
3.2.3.10.a	Water—Phase 1				X	
3.2.5.1	Reliability, Availability, Maintainability				X	
3.2.5.2.1	Design Life				X	
3.2.6.1	Environmental Conditions				X	
3.2.6.2	Chemical				X	
3.2.6.3	Radiation				X	
3.2.7	Transportability		X		X	
3.2.8	Flexibility and Expansion				X	
3.2.9	Portability					X
3.3	Design and Construction			X	X	
3.3.1.1	Toxic Products and Formulations	X				
3.3.1.2	Dangerous Waste	X				
3.3.1.3	Decontamination and Decommissioning				X	
3.3.2	Electromagnetic Radiation		X		X	
3.3.3	Nameplates and Product Markings	X				

Table 4-1. Double-Shell Tank System Quality Conformance Inspection Matrix. (8 Sheets)

Paragraph Number	Title	Inspection Element				
		Exam	Demo	Test	Anly	N/A
3.3.4	Workmanship	X				
3.3.5	Interchangeability	X			X	
3.3.6	Safety				X	
3.3.6.1.1	Occupational Radiological Protection				X	
3.3.6.1.2	Occupational Safety and Health Administration (OSHA) Standards	X			X	
3.3.6.2.1	Corrosion Prevention and Control				X	
3.3.6.2.2	Waste Composition				X	
3.3.6.2.3	Tank Temperature Limits				X	
3.3.6.2.4	Dome Vault Loading				X	
3.3.6.3.1	Secondary Containment and Leak Detection	X	X		X	
3.3.6.3.2	Spill Prevention and Controls				X	
3.3.6.3.3	Nonradioactive Airborne Emissions		X		X	
3.3.6.3.4	Radioactive Airborne Emissions		X		X	
3.3.6.3.5	Monitoring of Liquid Effluent Discharges to the Environment		X		X	
3.3.6.3.6	Radiation Protection of the Public and Environment				X	
3.3.6.3.7	Flammable Gas Design Requirements				X	
3.3.7	Human Engineering	X			X	

Table 4-1. Double-Shell Tank System Quality Conformance Inspection Matrix. (8 Sheets)

Paragraph Number	Title	Inspection Element				
		Exam	Demo	Test	Anly	N/A
3.3.8.1	Criticality Safety				X	
3.3.8.2	Nuclear Safety Classification				X	
3.3.9.1	General System and Information Security	X				
3.3.9.2	Radiation Area Security	X				
3.3.10	Government-Furnished Property Usage					X
3.3.11	Computer Resource Reserve Capacity					X
3.4	Documentation	X				
3.5.1	Maintenance and Operation				X	
3.5.1.1	Calibration	X				
3.5.2	Transportation of Hazardous Materials	X				
3.5.3.1	Solid Waste Acceptance Criteria				X	
3.6	Personnel and Training	X	X			
3.7	Characteristics of Subelements					X
3.8	Precedence					X
3.9	Qualification					X
3.10	Standard Sample					X
3.11	Preproduction					X

Note: Anly = Analysis; Demo = Demonstration; Exam = Examination; N/A = Not Applicable.

## **5.0 PREPARATION FOR DELIVERY**

Not applicable to this specification.



This page intentionally left blank.

## 6.0 NOTES

### 6.1 INTENDED USE

#### 6.1.1 Missions

The Double-Shell Tank System shall provide safe storage and management of legacy and new wastes, pretreat and qualify LAW and HLW feed, and retrieve and deliver waste to the 242-A Evaporator and the waste disposal facilities through Phase 1.

#### 6.1.2 Special Hazards

**6.1.2.1 High Radiation Levels.** The pits, transfer boxes, and other equipment in the tank farms have high radiations levels. High radiation levels should be assumed until measurements indicate otherwise.

### 6.2 ASSUMPTIONS

1. **Double-Shell Tank Storage Capacity.** No new DSTs will be constructed in support of Phase 1 activities. Modeling to date shows that no additional DST storage space is required for Phase 1. A decision on DST storage space, however, has not been documented. If future modeling indicates that additional space is required, a new requirement will be added to the specification.
2. **Transfer System.** Waste will be moved within the DST System using a piping network. Several studies (e.g., HNF-SD-TWR-AGA-001) have indicated that a piping network is preferred for transferring waste around the site.
3. **Process Volume.** Maximum order waste quantities will be processed by Phase 1 contractors. Designing to the maximum requirements will ensure the system will be capable of fulfilling Phase 1 mission objectives.
4. **High-Level Waste Feed.** All HLW feed will be drawn from aging waste tanks. HNF-SD-WM-SP-012 specifies the transfer of waste from the aging waste tanks to the LAW/HLW Plant.

### 6.3 ACRONYMS

AB	authorization basis
AGA	Alternatives Generation and Analysis
AWF	Aging Waste Facility
BIO	Basis for Interim Operation
CFR	<i>Code of Federal Regulations</i>
CP	Central Plateau
CSB	Canister Storage Building
D&D	decontamination and decommissioning
DC	dilute, complexed
DCRT	double-contained receiver tank
DN	dilute, noncomplexed
DOE	U.S. Department of Energy
DST	double-shell tank
EIS	Environmental Impact Statement
HLW	high-level waste
hsems	Hanford Site Environmental Management System
HSTD	Hanford Site Technical Database
IHLW	immobilized high-level waste
ILAW	immobilized low-activity waste
LAW	low-activity waste
MSC	Maintain Safe and Compliant
MUST	miscellaneous underground storage tank
O&M	Operations and Maintenance
OSHA	Occupational Safety and Health Administration
PFP	Plutonium Finishing Plant
PUREX	Plutonium Uranium Extraction (Facility)
ROD	Record of Decision
SNFP	Spent Nuclear Fuels Project
SST	single-shell tank
TBR	to be refined
TRU	transuranic
tsd	treatment, storage, and disposal

TWRS	Tank Waste Remediation System
WAC	<i>Washington Administrative Code</i>
WESF	Waste Encapsulation and Storage Facility

## 6.4 DEFINITIONS

Reserved: No plan to use this section.

## 6.5 REFERENCES

### **Code of Federal Regulations**

40 CFR 264, "Standards for Owners and Operators of Hazardous Waste Treatment, Storage, and Disposal Facilities," *Code of Federal Regulations*, as amended.

40 CFR 265, "Interim Status Standards for Owners and Operators of Hazardous Waste Treatment, Storage and Disposal Facilities," *Code of Federal Regulations*, as amended.

47 CFR 15, "Federal Communication Commission Rules and Regulations," Subpart B, "Emergency Management Center Regulations," *Code of Federal Regulations*, as amended.

### **Federal Register**

60 FR 8693, 1997, "Record of Decision for the Tank Waste Remediation System, Hanford Site, Richland, WA," *Federal Register*, Vol. 62, pp. 8693-8704 (February 26).

### **U.S. Department of Energy Orders**

DOE 6430.1A, *General Design Criteria*, U.S. Department of Energy, Washington, D.C.

### **Washington Administrative Codes**

WAC 173-200, "Water Quality Standards for Ground Waters in the State of Washington," *Washington Administrative Code*, as amended.

WAC 173-201A, "Water Quality Standards for Surface Waters in the State of Washington," *Washington Administrative Code*, as amended.

WAC 173-240, "Submission of Plans and Reports for Construction of Waste Water Facilities," *Washington Administrative Code*, as amended.

HNF-SD-WM-TRD-007  
Revision D

WAC 173-303, "Dangerous Waste Regulations," *Washington Administrative Code*, as amended.

WAC 173-360, "Underground Storage Tank Regulations," *Washington Administrative Code*, as amended.

**Hanford Site Procedures**

HNF-PRO-057, *Hanford General Employee Training*, Fluor Daniel Hanford, Inc., Richland, Washington.

HNF-PRO-097, *Design and Evaluation*, Fluor Daniel Hanford, Inc., Richland, Washington.

HNF-PRO-153, *Nuclear Process Operator Training Program*, Fluor Daniel Hanford, Inc., Richland, Washington.

HNF-PRO-154, *Responsibilities and Procedures for All Hazardous Material*, Fluor Daniel Hanford, Inc., Richland, Washington.

HNF-PRO-155, *Operations Management Fundamentals Training Program*, Fluor Daniel Hanford, Inc., Richland, Washington.

HNF-PRO-156, *Nonradioactive Hazardous Material/Waste Shipments*, Fluor Daniel Hanford, Inc., Richland, Washington.

HNF-PRO-157, *Radioactive Hazardous Material/Waste Shipments*, Fluor Daniel Hanford, Inc., Richland, Washington.

HNF-PRO-158, *Shipping and Receiving in the 1100 Area*, Fluor Daniel Hanford, Inc., Richland, Washington.

HNF-PRO-159, *ALARA Program Description*, Fluor Daniel Hanford, Inc., Richland, Washington.

HNF-PRO-160, *Cargo Tanks*, Fluor Daniel Hanford, Inc., Richland, Washington.

HNF-PRO-161, *Criticality Safety Training Program Description*, Fluor Daniel Hanford, Inc., Richland, Washington.

HNF-PRO-162, *Temporarily Upgrading Non-Exempt Employees to Exempt*, Fluor Daniel Hanford, Inc., Richland, Washington.

HNF-SD-WM-TRD-007

Revision D

- HNF-PRO-163, *Documentation and Record Keeping, Fluor Daniel Hanford, Inc.*, Richland, Washington.
- HNF-PRO-222, *Quality Assurance Records, Fluor Daniel Hanford, Inc.*, Richland, Washington.
- HNF-PRO-224, *Document Control, Fluor Daniel Hanford, Inc.*, Richland, Washington.
- HNF-PRO-242, *Engineering Drawing Requirements, Fluor Daniel Hanford, Inc.*, Richland, Washington.
- HNF-PRO-334, *Criticality Safety General Requirements, Fluor Daniel Hanford, Inc.*, Richland, Washington.
- HNF-PRO-394, *Physical Protection of Properties and Facilities, Fluor Daniel Hanford, Inc.*, Richland, Washington.
- HNF-PRO-445, *Design Verification Requirements, Fluor Daniel Hanford, Inc.*, Richland, Washington.
- HNF-PRO-451, *Regulated Substance Management, Fluor Daniel Hanford, Inc.*, Richland, Washington.
- HNF-PRO-452, *NEPA, SEPA, Cultural and Natural Resources, Fluor Daniel Hanford, Inc.*, Richland, Washington.
- HNF-PRO-455, *Solid Waste Management, Fluor Daniel Hanford, Inc.*, Richland, Washington.
- HNF-PRO-537, *Criticality Safety Control of Fissionable Material, Fluor Daniel Hanford, Inc.*, Richland, Washington.
- HNF-PRO-538, *Criticality Safety Training, Fluor Daniel Hanford, Inc.*, Richland, Washington.
- HNF-PRO-539, *Criticality Safety Evaluation, Fluor Daniel Hanford, Inc.*, Richland, Washington.
- HNF-PRO-540, *Criticality Prevention Specifications, Fluor Daniel Hanford, Inc.*, Richland, Washington.
- HNF-PRO-541, *Criticality Safety Postings, Fluor Daniel Hanford, Inc.*, Richland, Washington.
- HNF-PRO-542, *Criticality Liability Fissionable Material, Fluor Daniel Hanford, Inc.*, Richland, Washington.

HNF-SD-WM-TRD-007  
Revision D

- HNF-PRO-543, *Fissionable Material Storage, Fluor Daniel Hanford, Inc.*, Richland, Washington.
- HNF-PRO-544, *Criticality Plant Configuration Control, Fluor Daniel Hanford, Inc.*, Richland, Washington.
- HNF-PRO-545, *Fissionable Material Packaging and Transportation, Fluor Daniel Hanford, Inc.*, Richland, Washington.
- HNF-PRO-546, *Criticality Alarm System, Fluor Daniel Hanford, Inc.*, Richland, Washington.
- HNF-PRO-547, *Criticality Safety for Firefighting, Fluor Daniel Hanford, Inc.*, Richland, Washington.
- HNF-PRO-548, *Criticality Safety Inspections and Assessments, Fluor Daniel Hanford, Inc.*, Richland, Washington.
- HNF-PRO-549, *Criticality Safety Nonconformance Response, Fluor Daniel Hanford, Inc.*, Richland, Washington.
- HNF-PRO-550, *Criticality or Potential Criticality Accidents, Fluor Daniel Hanford, Inc.*, Richland, Washington.
- HNF-PRO-700, *Safety Analysis and Technical Safety Requirements, Fluor Daniel Hanford, Inc.*, Richland, Washington.
- HNF-PRO-701, *Safety Analysis Process-Existing Facility, Fluor Daniel Hanford, Inc.*, Richland, Washington.
- HNF-PRO-702, *Safety Analysis Process-Facility Change or Modification, Fluor Daniel Hanford, Inc.*, Richland, Washington.
- HNF-PRO-703, *Safety Analysis Process-New Project, Fluor Daniel Hanford, Inc.*, Richland, Washington.
- HNF-PRO-704, *Hazard and Accident Analysis Process, Fluor Daniel Hanford, Inc.*, Richland, Washington.
- HNF-PRO-1819, *PHMC Engineering Requirements, Fluor Daniel Hanford, Inc.*, Richland, Washington.

**Documents**

- ASTM G75-95, *Standard Test Method for G75-95 Determination of Slurry Abrasivity (Miller Number) and Slurry Abrasion Response of Materials (SAR Number)*, 1995, American Society for Testing and Materials, West Conshohocken, Pennsylvania.
- HNF-2004, Rev. 0, *Estimated Dose to In-Tank Equipment: Phase 1 Feed Delivery*, 1998, Fluor Daniel Hanford, Inc., Richland, Washington.
- HNF-2288, *Miscellaneous Supporting Information for: System Specification for the Double-Shell Tank System (HNF-SD-TRD-007)*, 1998, Fluor Daniel Hanford, Inc., Richland, Washington.
- HNF-MP-599, *Project Hanford Quality Assurance Program Description*, 1998, Fluor Daniel Hanford, Inc., Richland, Washington.
- HNF-SD-TWR-AGA-001, Rev. 1, *Alternative Generation Analysis for Phase 1 Intermediate Waste Feed Staging System Design Requirements*, 1997, Fluor Daniel Hanford, Inc., Richland, Washington.
- HNF-SD-TWR-CSUD-001, Rev. 0, *Tank Waste Remediation System Technical Baseline Database Manager Definition Document*, 1997, Lockheed Martin Hanford Corporation for Fluor Daniel Hanford, Inc., Richland, Washington.
- HNF-SD-WM-013, Rev. 0, *HSTD/Data Dictionary*, 1997, Fluor Daniel Hanford, Inc., Richland, Washington.
- HNF-SD-WM-BIO-001, Rev. 0, *Tank Waste Remediation System Basis for Interim Operation*, 1997, Fluor Daniel Hanford, Inc., Richland, Washington.
- HNF-SD-WM-DQO-001, Rev. 2, *Data Quality Objectives for Tank Farm Waste Compatibility Program*, 1997, Fluor Daniel Hanford, Inc., Richland, Washington.
- HNF-SD-WM-DTR-046, Rev. 0, *Results of Dilution Studies With Waste From Tank 241-AN-105*, 1997, Numatec Hanford Corporation for Fluor Daniel Hanford, Inc., Richland, Washington.
- HNF-SD-WM-ER-029, Rev. 23, *Tank Waste Remediation System Operational Waste Volume Project*, 1997, Fluor Daniel Hanford, Inc., Richland, Washington.



HNF-SD-WM-TRD-007

Revision D

- HNF-SD-WM-MAR-008, Rev. 2, *Tank Waste Remediation System Mission Analysis Report*, 1998, Lockheed Martin Hanford Corporation for Fluor Daniel Hanford, Inc., Richland, Washington.
- HNF-SD-WM-SEMP-002, Rev. 1, *Tank Waste Remediation System, Systems Engineering Management Plan*, 1998, Fluor Daniel Hanford, Inc., Richland, Washington.
- HNF-SD-WM-SP-012, Rev. 0, *Tank Waste Remediation System Operation and Utilization Plan*, Vol. I and II, 1997, Numatec Hanford Corporation for Fluor Daniel Hanford, Inc., Richland, Washington.
- HNF-SD-WM-TR-026, Rev. 5, *Tank Waste Remediation System Dangerous Waste Training Plan*, 1997, Fluor Daniel Hanford, Inc., Richland, Washington.
- HNF-SD-WM-TSR-006, Rev. F-2, *Tank Waste Remediation System Technical Safety Requirements*, 1997, Fluor Daniel Hanford, Inc., Richland, Washington.
- HSRCM-1, Rev. 2, *Hanford Site Radiological Control Manual*, U.S. Department of Energy, Washington, D.C.
- OSD-T-151-00007, *Unclassified Operation Specifications for the 241-AN, AP, AW, AY, AZ, & SY Tank Farms*, Fluor Daniel Hanford, Inc., Richland, Washington.
- WHC-CM-7-5, Release 90, *Environmental Compliance*, 1997, Westinghouse Hanford Company, Richland, Washington.
- WHC-EP-0063-04, *Hanford Site Solid Waste Acceptance Criteria*, 1993, Westinghouse Hanford Company, Richland, Washington.
- WHC-SD-GN-ER-501, Rev. 0-A, *Natural Phenomena Hazards, Hanford Site, South-Central Washington*, 1996, Westinghouse Hanford Company, Richland, Washington.
- WHC-SD-WM-DQO-014, Rev. 1A, *242-A Evaporator/Liquid Effluent Retention Facility Data Quality Objectives*, 1995, Westinghouse Hanford Company, Richland, Washington.
- WHC-SD-WM-EV-053, Rev. 4, *Double-Shell Tank Waste Analysis Plan*, Rev. 4, 1996, Westinghouse Hanford Company, Richland, Washington.
- WHC-SD-WM-HSP-002, Rev. 2-F, *Tank Farm Health and Safety Plan*, 1996, Westinghouse Hanford Company, Richland, Washington.

HNF-SD-WM-TRD-007

Revision D

WHC-SD-WM-OCD-015, Rev. 1, *Tank Waste Farm Transfer Compatibility Program*, 1995,  
Westinghouse Hanford Company, Richland, Washington.

HNF-SD-WM-TRD-007  
Revision D

This page intentionally left blank.

## 7.0 LIST OF APPENDICES

Appendix A      Requirements Traceability

HNF-SD-WM-TRD-007  
Revision D

This page intentionally left blank.

HNF-SD-WM-TRD-007  
Revision D

**APPENDIX A**  
**REQUIREMENTS TRACEABILITY**

HNF-SD-WM-TRD-007  
Revision D

This page intentionally left blank.

**APPENDIX A  
REQUIREMENTS TRACEABILITY**

Table A-1. Double-Shell Tank System Performance Requirements Traceability Matrix. (14 Sheets)

Paragraph number	Title	Source of requirement
3.2.1.1.a	Double-Shell Tank System Storage Capacity, Phase I	No new tanks needed before 2004—Letter, 9550111.  Existing capacity—WHC-EP-0182-99, Table B-1.  Turnover of Two Tanks to Phase I Vendors—Contract Numbers DE-AC06-96RL13308 and DE-AC06-96RL13309, Section C, Interface Description 21, Interface Description.
3.2.1.1.b	Double-Shell Tank System Spare Storage Capacity	DOE Order 5820.2A, Chapter I, Section 3(b)(4)(d).
3.2.1.1.1.a	West Double-Shell Tank System Storage Capacity, Phase I	No new tanks needed before 2004—Letter, 9550111.  Existing capacity—WHC-EP-0182-99, Table B-1.
3.2.1.1.2.a	East Double-Shell Tank System Storage Capacity, Phase I	No new tanks needed before 2004—Letter, 9550111.  Existing capacity—WHC-EP-0182-99, Table B-1.  Turnover of Two Tanks to Phase I Vendors—Contract Numbers DE-AC06-96RL13308 and DE-AC06-96RL13309, Section C, Interface Description 21, Interface Description.
3.2.1.1.3.a	204-AR Annual Capacity	HNF-2168.
3.2.1.1.3.b	204-AR Batch Transfer	HNF-2168.
3.2.1.1.3.c	204-AR Transferred Waste Properties	HNF-SD-WM-DQO-001.
3.2.1.1.4.a	West Area Liquid Waste Annual Capacity	HNF-2168.
3.2.1.1.4.b	Waste Batch Size—West Area	HNF-2168.
3.2.1.1.5.a	East Area Liquid Waste Annual Capacity	HNF-2168.
3.2.1.1.5.b	Waste Batch Size—East Area	HNF-2168.



Table A-1. Double-Shell Tank System Performance Requirements Traceability Matrix. (14 Sheets)

Paragraph number	Title	Source of requirement
3.2.1.1.6.a	Annual Volume of Concentrated Waste	HNF-2168.
3.2.1.1.6.b	Concentrated Waste Receipt Rate	See traceability for Sections 3.2.3.6.a and 3.2.3.6.b.
3.2.1.1.7.a	Evaporator Purge Batch Size	See traceability for Section 3.2.3.6.c.
3.2.1.1.8.a	Treatment Plant Waste Product Volume, Phase I	HNF-2168.
3.2.1.1.8.b	Treatment Plant Waste Receipt Requirements	See traceability for Sections 3.2.3.7 and 3.2.3.8.
3.2.1.2.a	Low-Activity Waste Staging Quantity, Phase I	HNF-2168.
3.2.1.2.b	Space Management Annual Waste Volume, Phase I	HNF-2168.
3.2.1.2.c	Evaporator Feed Volume, Phase I	HNF-2168.
3.2.1.2.d	Unretrieved Waste Properties	TWR-2244. HNF-SD-WM-DTR-046.
3.2.1.2.1.a	Supernatant Preparation—West Area	HNF-2168 (Volume)/HNF-SD-WM-DQO-001 (Properties).
3.2.1.2.1.b	Soluble Waste Preparation—West Area	HNF-2168 (Volume)/HNF-SD-WM-DQO-001 (Properties).
3.2.1.2.1.c	Insoluble Waste Preparation—West Area	HNF-2168 (Volume)/HNF-SD-WM-DQO-001 (Properties).
3.2.1.2.2.a	200 West Area Waste Batch Transfer	HNF-2168.
3.2.1.2.2.b	Waste Pumpability	HNF-SD-WM-DQO-001. WHC-SD-WM-OCD-015.
3.2.1.2.3.a	Cross-Site Waste Transfer Volume	HNF-2168.
3.2.1.2.3.b	Waste Pumpability	HNF-SD-WM-DQO-001. WHC-SD-WM-OCD-015.
3.2.1.2.4.a	Supernatant Preparation—East Area	HNF-2168 (Volume)/HNF-SD-WM-DQO-001 (Properties).
3.2.1.2.4.b	Soluble Waste Preparation—East Area	HNF-2168 (Volume)/HNF-SD-WM-DQO-001 (Properties).
3.2.1.2.4.c	Insoluble Waste Preparation—East Area	HNF-2168 (Volume)/HNF-SD-WM-DQO-001 (Properties).

Table A-1. Double-Shell Tank System Performance Requirements Traceability Matrix. (14 Sheets)

Paragraph number	Title	Source of requirement
3.2.1.2.5.a	200 East Area Waste Batch Transfer	HNF-2168.
3.2.1.2.5.b	Waste Pumpability	HNF-SD-WM-DQO-001. WHC-SD-WM-OCD-015.
3.2.1.2.6.a	Evaporator Feed Annual Volume	HNF-2168.
3.2.1.2.6.b	Evaporator Feed Rate	WHC-SD-WM-SAR-023, Section 4.1.3.
3.2.1.2.6.c	Evaporator Feed Requirements	WHC-SD-WM-DQO-014.
3.2.1.2.6.d	Waste Pumpability	HNF-SD-WM-DQO-001. WHC-SD-WM-OCD-015.
3.2.1.2.7.a	Low-Activity Waste Staging Batch Volumes	HNF-2168.
3.2.1.2.7.b	Waste Pumpability	HNF-SD-WM-DQO-001. WHC-SD-WM-OCD-015.
3.2.1.3.a	Low-Activity Waste Feed Composition and Physical Properties, Phase I	Feed Composition Requirements—Contract Numbers DE-AC06-96RL13308 and DE-AC06-96RL13309, Section C, Specification 7, Section 7.2.
3.2.1.3.b	Waste Compatibility	HNF-SD-WM-DQO-001.
3.2.1.3.c	Low-Activity Waste Feed Production Quantities, Phase I	Contract Numbers DE-AC06-96RL13308 and DE-AC06-96RL13309.
3.2.1.3.d	Low-Activity Waste Feed Frequency, Phase I	TWR-2244.
3.2.1.3.1.a	Low-Activity Waste Staging Batch Size, Phase I	HNF-2168.
3.2.1.3.2.a	Low-Activity Waste Feed Batches, Phase I	HNF-2168.
3.2.1.3.2.b	Waste Pumpability	HNF-SD-WM-DQO-001. WHC-SD-WM-OCD-015.

Table A-1. Double-Shell Tank System Performance Requirements Traceability Matrix. (14 Sheets)

Paragraph number	Title	Source of requirement
3.2.1.4.a	High-Level Waste Feed Composition	High-Level Waste Feed Composition—Contract Numbers DE-AC06-96RL13308 and DE-AC06-96RL13309, Specification 8.
3.2.1.4.b	High-Level Waste Feed Physical Properties	High-Level Waste Physical Properties—Contract Numbers DE-AC06-96RL13308 and DE-AC06-96RL13309, Specification 8.
3.2.1.4.c	High-Level Waste Feed Production Quantities, Phase 1	Waste Transfer Time—Contract Numbers DE-AC06-96RL13308 and DE-AC06-96RL13309, Section C, Clause H.9, d.
3.2.1.4.d	High-Level Waste Feed Frequency, Phase 1	HNF-2168.
3.2.1.4.1.a	Sludge Wash Batch Volume	HNF-2168.
3.2.1.4.1.b	High-Level Waste Sludge Washing Critical Component Ratios	TWR-2244.
3.2.1.4.2.a	Sludge Wash Supernatant Total Volume	HNF-2168.
3.2.1.4.2.b	Sludge Wash Supernatant Batch Volume	HNF-2168.
3.2.1.4.2.c	Waste Pumpability	HNF-SD-WM-DQO-001. WHC-SD-WM-OCD-015.
3.2.1.4.3.a	High-Level Waste Feed Batch Sizes, Phase 1	HNF-2168.
3.2.1.4.3.b	High-Level Waste Feed Preparation, Phase 1	HNF-2168.
3.2.1.4.4.a	High-Level Waste Feed Batch Transfer Volume	
3.2.1.4.4.b	Waste Pumpability	HNF-SD-WM-DQO-001.
3.2.1.5.a	Double-Shell Tank System Waste Sampling Requirements	Feed Composition Requirements—Contract Numbers DE-AC06-96RL13308 and DE-AC06-96RL13309, Section C, Specification 7, Section 7.2. High-Level Waste Feed Composition—Contract Numbers DE-AC06-96RL13308 and DE-AC06-96RL13309, Specification 8.
3.2.3.1.a	204-AR Waste Receipt Properties	Chemical Composition—OSD-T-151-00008-MISC, Section 8.2, Paragraph 1. Fissile Material—OSD-T-151-00008-MISC, Section 8.2, Paragraph 3.

Table A-1. Double-Shell Tank System Performance Requirements Traceability Matrix. (14 Sheets)

Paragraph number	Title	Source of requirement
3.2.3.2.a	Plutonium Finishing Plant Waste Annual Volume	HNF-2168.
3.2.3.2.b	Plutonium Finishing Plant Waste Properties	HNF-SD-WM-DQO-001. WHC-SD-WM-EV-053. HNF-2288, Sections E, F, and G. WHC-SD-WM-OCD-015. HNF-SD-WM-TSR-006, AC 5.7, 5.8, and 5.12.
3.2.3.3.a	S Plant Waste Volume	HNF-2168.
3.2.3.3.b	S Plant Waste Properties	HNF-SD-WM-DQO-001. WHC-SD-WM-EV-053. HNF-2288, Sections E, F, and G. WHC-SD-WM-OCD-015. HNF-SD-WM-TSR-006, AC 5.7, 5.8, and 5.12.
3.2.3.4.a	B Plant/Waste Encapsulation and Storage Facility Waste Volume	HNF-2168.
3.2.3.4.b	B Plant/Waste Encapsulation and Storage Facility Waste Properties	HNF-SD-WM-DQO-001. WHC-SD-WM-EV-053. HNF-2288, Sections E, F, and G. WHC-SD-WM-OCD-015. HNF-SD-WM-TSR-006, AC 5.7, 5.8, and 5.12.

Table A-1. Double-Shell Tank System Performance Requirements Traceability Matrix. (14 Sheets)

Paragraph number	Title	Source of requirement
3.2.3.5.a	West Single-Shell Tank Salt Well Liquid Waste Volume	HNF-2168.
3.2.3.5.b	East Single-Shell Tank Salt Well Liquid Waste Volume	HNF-2168.
3.2.3.5.c	Single-Shell Tank Salt Well Liquid Waste Properties	HNF-SD-WM-DQO-001. WHC-SD-WM-EV-053. HNF-2288, Sections E, F, and G. WHC-SD-WM-OCD-015. HNF-SD-WM-TSR-006, AC 5.7, 5.8, and 5.12.
3.2.3.5.d	Single-Shell Tank Waste Retrieval Volume, Phase 1	HNF-2168.
3.2.3.6.a	Concentrated Waste Receipt Rate	WHC-SD-WM-SAR-023, Section 4.1.3.
3.2.3.6.b	Concentrated Waste Composition	WHC-SD-WM-SAR-023, Table 4-8.
3.2.3.6.c	Emergency Transfer Volume from Evaporator	Maximum Evaporator Volume—WHC-SD-WM-SAR-023, Section 5.2.3.2.2.2. Emergency Transfer Rate—WHC-SD-WM-SAR-023, Sections 9.3.1.1.1 and 9.3.1.1.2. WHC-SD-WM-SAR-023, Section 5.2.3.2.2.
3.2.3.7.a	Low-Activity Waste Plant Entrained Solids Total Volume	HNF-SD-WM-SP-012. Product to be Returned—Contract Numbers DE-AC06-96RL13308 and DE-AC06-96RL13309, Section C, Clause H.9, I.
3.2.3.7.b	Entrained Solids Batch Volume Requirements	Contract Numbers DE-AC06-96RL13308 and DE-AC06-96RL13309, Section C, Clause H.9, I, Section 3.2.2.3.

Table A-1. Double-Shell Tank System Performance Requirements Traceability Matrix. (14 Sheets)

Paragraph number	Title	Source of requirement
3.2.3.7.c	Entrained Solids Physical Properties	Contract Numbers DE-AC06-96RL13308 and DE-AC06-96RL13309, Section C, Clause H.9, I, Section 9.2.2.6, Table TS-9.1.
3.2.3.7.d	Waste Product Sodium Content	Contract Numbers DE-AC06-96RL13308 and DE-AC06-96RL13309, Section C, Clause H.9, I, Section 10.2.2.3.
3.2.3.7.e	Entrained Solids Cesium-137 Content	Contract Numbers DE-AC06-96RL13308 and DE-AC06-96RL13309, Section C, Clause H.9, I, Section 3.2.2.1.
3.2.3.7.f	Entrained Solids Technetium-99 Content	Contract Numbers DE-AC06-96RL13308 and DE-AC06-96RL13309, Section C, Clause H.9, I, Section 3.2.2.2.
3.2.3.7.g	Plutonium Content	Contract Numbers DE-AC06-96RL13308 and DE-AC06-96RL13309, Section C, Clause H.9, I, Section 9.2.2.3.
3.2.3.7.h	Separable Organics	Contract Numbers DE-AC06-96RL13308 and DE-AC06-96RL13309, Section C, Clause H.9, I, Section 9.2.2.4.
3.2.3.7.i	Scaling	Contract Numbers DE-AC06-96RL13308 and DE-AC06-96RL13309, Section C, Clause H.9, I, Section 9.2.2.7.
3.2.3.7.j	Stability Prevention of Exothermic Reaction	Contract Numbers DE-AC06-96RL13308 and DE-AC06-96RL13309, Section C, Clause H.9, I, Section 4.2.2.8.
3.2.3.7.k	Immobilized High-Level Waste Impacts	Contract Numbers DE-AC06-96RL13308 and DE-AC06-96RL13309, Section C, Clause H.9, I, Section 10.2.2.1.
3.2.3.7.l	Waste Pumpability	WHC-SD-WM-OCD-015 and OSD-T-151-00007, Section 7.2.1.
3.2.3.8.a	Entrained Solids Total Volume	Entrained Solids Volume—HNF-SD-WM-SP-012.
3.2.3.8.b	Entrained Solids Properties	Product to be Returned—Contract Numbers DE-AC06-96RL13308 and DE-AC06-96RL13309, Section C, Clause H.9, I.
3.2.3.9.a	Electrical Power	Reserved.
3.2.3.10.a	Water—Phase I	HNF-2168.
3.2.5.1	Reliability, Availability, Maintainability	HNF-2288, Section B.
3.2.5.2.1	Design Life	Tri-Party Agreement, Milestone M-51-00.

A-9

Revision D

Table A-1. Double-Shell Tank System Performance Requirements Traceability Matrix. (14 Sheets)

Paragraph number	Title	Source of requirement
3.2.6.1	Environmental Conditions	WHC-SD-GN-ER-501. HNF-PRO-097.
3.2.6.2	Chemical	a) DOE Order 6430.1A, Section 1300-3.4.2, "Environmental Qualification of Equipment." b) HNF-SD-WM-SP-012.
3.2.6.3	Radiation	HNF-2004.
3.2.7	Transportability	HNF-PRO-157.
3.2.8	Flexibility and Expansion	DOE Order 6430.1A, Section 0110-3, "Flexibility."
3.2.9	Portability	Not applicable.
3.3	Design and Construction	DOE Order 6430.1A.
3.3.1.1	Toxic Products and Formulations	WHC-SD-WM-HSP-002. HNF-PRO-451.
3.3.1.2	Dangerous Waste	WAC 173-303.
3.3.1.3	Decontamination and Decommissioning	DOE Order 6430.1A.
3.3.2	Electromagnetic Radiation	47 CFR 15, Subpart B.
3.3.3	Nameplates and Product Markings	DOE Order 6430.1A, Section 1300-12.4.11
3.3.4	Workmanship	Reserved.
3.3.5	Interchangeability	HNF-2288, Section A.
3.3.6	Safety	HNF-SD-WM-BIO-001.
3.3.6.1.1	Occupational Radiological Protection	HSRCM-1.
3.3.6.1.2	Occupational Safety and Health Administration (OSHA) Standards	WHC-SD-WM-HSP-002.
3.3.6.2.1	Corrosion Prevention and Control	WAC 173-303-640, "Tank Systems."

Table A-1. Double-Shell Tank System Performance Requirements Traceability Matrix. (14 Sheets)

Paragraph number	Title	Source of requirement
3.3.6.2.2	Waste Composition	HNF-SD-WM-DQO-001.
3.3.6.2.3	Tank Temperature Limits	HNF-SD-WM-TSR-006.
3.3.6.2.4	Dome Vault Loading	HNF-SD-WM-TSR-006, Section 5.16.
3.3.6.3.1	Secondary Containment and Leak Detection	a) 40 CFR 264.193, "Containment and Detection of Releases." b) 40 CFR 265.193, "Containment and Detection of Releases." c) WAC 173-360, "Underground Storage Tank Regulations." d) WAC 173-303-640, "Tank Systems."
3.3.6.3.2	Spill Prevention and Controls	a) 40 CFR 264.194, "General Operating Requirements." b) 40 CFR 265.194, "General Operating Requirement." c) WAC 173-303-630, "Use and Management of Containers." d) WAC 173-303-640, "Tank Systems."
3.3.6.3.3	Nonradioactive Airborne Emissions	WHC-CM-7-5.
3.3.6.3.4	Radioactive Airborne Emissions	WHC-CM-7-5.
3.3.6.3.5	Monitoring of Liquid Effluent Discharges to the Environment	WAC 173-200, -201A, and -240. WAC 173-303-645, "Releases From Regulated Units."
3.3.6.3.6	Radiation Protection of the Public and Environment	HNF-PRO-451, -452, and -455.
3.3.6.3.7	Flammable Gas Design Requirements	HNF-SD-WM-TSR-006.
3.3.7	Human Engineering	DOE Order 6430.1A, Section 1300-12, "Human Factors Engineering."
3.3.8.1	Criticality Safety	HNF-PRO-334, -537 through -550.
3.3.8.2	Nuclear Safety Classification	HNF-SD-WM-BIO-001, Tables 5.3-2 and 5.3-3.  HNF-PRO-700 through -704.
3.3.9.1	General System and Information Security	HNF-PRO-394.
3.3.9.2	Radiation Area Security	HSRCM-1, Ch. 2.
3.3.10	Government-Furnished Property Usage	Not applicable.
3.3.11	Computer Resource Reserve Capacity	Not applicable.

REVISION D



Table A-1. Double-Shell Tank System Performance Requirements Traceability Matrix. (14 Sheets)

Paragraph number	Title	Source of requirement
3.4	Documentation	HNF-PRO-222, -224, and -242.
3.5.1	Maintenance and Operation	DOE 5820.2A, Chapter 1, Paragraph 3.b(2)(j). 10 CFR 835.1002, Paragraph (b).
3.5.1.1	Calibration	DOE Order 6430.1A
3.5.2	Transportation of Hazardous Materials	HNF-PRO-154 through -163.
3.5.3.1	Solid Waste Acceptance Criteria	HNF-PRO-455.
3.6	Personnel and Training	HNF-PRO-057 and -153. HNF-SD-WM-TR-026.

A-12

**Code of Federal Regulations**

10 CFR 835.1002, "Facility Design and Modifications," *Code of Federal Regulations*, as amended.

40 CFR 264, "Standards for Owners and Operators of Hazardous Waste Treatment, Storage, and Disposal Facilities," *Code of Federal Regulations*, as amended.

40 CFR 265, "Interim Status Standards for Owners and Operators of Hazardous Waste Treatment, Storage and Disposal Facilities," *Code of Federal Regulations*, as amended.

47 CFR 15, "Federal Communication Commission Rules and Regulations," Subpart B, "Emergency Management Center Regulations," *Code of Federal Regulations*, as amended.

**U.S. Department of Energy Orders**

DOE Order 5820.2A, *Radioactive Waste Management*, U.S. Department of Energy, Washington, D.C.

DOE Order 6430.1A, *General Design Criteria*, U.S. Department of Energy, Washington, D.C.

**Washington Administrative Code**

- WAC 173-200, "Water Quality Standards for Ground Waters in the State of Washington," *Washington Administrative Code*, as amended.
- WAC 173-201A, "Water Quality Standards for Surface Waters in the State of Washington," *Washington Administrative Code*, as amended.
- WAC 173-240, "Submission of Plans and Reports for Construction of Waste Water Facilities," *Washington Administrative Code*, as amended.
- WAC 173-303, "Dangerous Waste Regulations," *Washington Administrative Code*, as amended.
- WAC 173-360, "Underground Storage Tank Regulations," *Washington Administrative Code*, as amended.

**Hanford Site Procedures**

- HNF-PRO-057, *Hanford General Employee Training, Fluor Daniel Hanford, Inc.*, Richland, Washington.
- HNF-PRO-097, *Design and Evaluation, Fluor Daniel Hanford, Inc.*, Richland, Washington.
- HNF-PRO-153, *Nuclear Process Operator Training Program, Fluor Daniel Hanford, Inc.*, Richland, Washington.
- HNF-PRO-154, *Responsibilities and Procedures for All Hazardous Material, Fluor Daniel Hanford, Inc.*, Richland, Washington.
- HNF-PRO-155, *Operations Management Fundamentals Training Program, Fluor Daniel Hanford, Inc.*, Richland, Washington.
- HNF-PRO-156, *Nonradioactive Hazardous Material/Waste Shipments, Fluor Daniel Hanford, Inc.*, Richland, Washington.
- HNF-PRO-157, *Radioactive Hazardous Material/Waste Shipments, Fluor Daniel Hanford, Inc.*, Richland, Washington.
- HNF-PRO-158, *Shipping and Receiving in the 1100 Area, Fluor Daniel Hanford, Inc.*, Richland, Washington.
- HNF-PRO-159, *ALARA Program Description, Fluor Daniel Hanford, Inc.*, Richland, Washington.
- HNF-PRO-160, *Cargo Tanks, Fluor Daniel Hanford, Inc.*, Richland, Washington.
- HNF-PRO-161, *Criticality Safety Training Program Description, Fluor Daniel Hanford, Inc.*, Richland, Washington.
- HNF-PRO-162, *Temporarily Upgrading Non-Exempt Employees to Exempt, Fluor Daniel Hanford, Inc.*, Richland, Washington.

HNF-PRO-163, *Documentation and Record Keeping*, Fluor Daniel Hanford, Inc., Richland, Washington.

HNF-PRO-222, *Quality Assurance Records*, Fluor Daniel Hanford, Inc., Richland, Washington.

HNF-PRO-224, *Document Control*, Fluor Daniel Hanford, Inc., Richland, Washington.

HNF-PRO-242, *Engineering Drawing Requirements*, Fluor Daniel Hanford, Inc., Richland, Washington.

HNF-PRO-334, *Criticality Safety General Requirements*, Fluor Daniel Hanford, Inc., Richland, Washington.

HNF-PRO-394, *Physical Protection of Properties and Facilities*, Fluor Daniel Hanford, Inc., Richland, Washington.

HNF-PRO-451, *Regulated Substance Management*, Fluor Daniel Hanford, Inc., Richland, Washington.

HNF-PRO-452, *NEPA, SEPA, Cultural and Natural Resources*, Fluor Daniel Hanford, Inc., Richland, Washington.

HNF-PRO-455, *Solid Waste Management*, Fluor Daniel Hanford, Inc., Richland, Washington.

HNF-PRO-537, *Criticality Safety Control of Fissionable Material*, Fluor Daniel Hanford, Inc., Richland, Washington.

HNF-PRO-538, *Criticality Safety Training*, Fluor Daniel Hanford, Inc., Richland, Washington.

HNF-PRO-539, *Criticality Safety Evaluation*, Fluor Daniel Hanford, Inc., Richland, Washington.

HNF-PRO-540, *Criticality Prevention Specifications*, Fluor Daniel Hanford, Inc., Richland, Washington.

HNF-PRO-541, *Criticality Safety Postings*, Fluor Daniel Hanford, Inc., Richland, Washington.

HNF-PRO-542, *Criticality Liability Fissionable Material*, Fluor Daniel Hanford, Inc., Richland, Washington.

HNF-PRO-543, *Fissionable Material Storage*, Fluor Daniel Hanford, Inc., Richland, Washington.

HNF-PRO-544, *Criticality Plant Configuration Control*, Fluor Daniel Hanford, Inc., Richland, Washington.

HNF-PRO-545, *Fissionable Material Packaging and Transportation*, Fluor Daniel Hanford, Inc., Richland, Washington.

HNF-PRO-546, *Criticality Alarm System*, Fluor Daniel Hanford, Inc., Richland, Washington.

HNF-PRO-547, *Criticality Safety for Firefighting*, Fluor Daniel Hanford, Inc., Richland, Washington.

HNF-PRO-548, *Criticality Safety Inspections and Assessments*, Fluor Daniel Hanford, Inc., Richland, Washington.

HNF-PRO-549, *Criticality Safety Nonconformance Response*, Fluor Daniel Hanford, Inc., Richland, Washington.

HNF-PRO-550, *Criticality or Potential Criticality Accidents*, Fluor Daniel Hanford, Inc., Richland, Washington.

HNF-PRO-700, *Safety Analysis and Technical Safety Requirements*, Fluor Daniel Hanford, Inc., Richland, Washington.

HNF-PRO-701, *Safety Analysis Process-Existing Facility*, Fluor Daniel Hanford, Inc., Richland, Washington.

HNF-PRO-702, *Safety Analysis Process-Facility Change or Modification*, Fluor Daniel Hanford, Inc., Richland, Washington.

HNF-PRO-703, *Safety Analysis Process-New Project*, Fluor Daniel Hanford, Inc., Richland, Washington.

HNF-PRO-704, *Hazard and Accident Analysis Process*, Fluor Daniel Hanford, Inc., Richland, Washington.

HNF-PRO-1819, *PHMC Engineering Requirements*, Fluor Daniel Hanford, Inc., Richland, Washington.

#### **Documents**

DE-AC06-96RL13308, *British Nuclear Fuels Laboratory Privatization Contract*, 1996, U.S. Department of Energy, Richland Operations Office, Richland, Washington.

DE-AC06-96RL13309, *Lockheed Martin Advanced Environmental Systems Privatization Contract*, 1996, U.S. Department of Energy, Richland, Operations Office, Richland, Washington.

HNF-2004, Rev. 0, *Estimated Dose to In-Tank Equipment: Phase 1 Feed Delivery*, 1998, Fluor Daniel Hanford, Inc., Richland, Washington.

HNF-2168, Rev. 0, *Performance Requirements for Double-Shell Tank System: Phase 1*, 1998, Fluor Daniel Hanford, Inc., Richland, Washington.

HNF-2288, *Miscellaneous Supporting Information for: System Specification for the Double-Shell Tank System (HNF-SD-TRD-007)*, 1998, Fluor Daniel Hanford, Inc., Richland, Washington.

HNF-SD-WM-BIO-001, Rev. 0, *Tank Waste Remediation System Basis for Interim Operation*, 1997, Fluor Daniel Hanford, Inc., Richland, Washington.

- HNF-SD-WM-DQO-001, Rev. 2, *Data Quality Objectives for Tank Farm Waste Compatibility Program*, 1997, Fluor Daniel Hanford, Inc., Richland, Washington.
- HNF-SD-WM-DTR-046, Rev. 0, *Results of Dilution Studies with Waste from Tank 241-AN-105*, 1997, Numatec Hanford Corporation for Fluor Daniel Hanford, Inc., Richland, Washington.
- HNF-SD-WM-SP-012, Rev. 0, *Tank Waste Remediation System Operation and Utilization Plan*, Vol. I and II, 1997, Numatec Hanford Corporation, Richland, Washington.
- HNF-SD-WM-TR-026, Rev. 5, *Tank Waste Remediation System Dangerous Waste Training Plan*, 1997, Fluor Daniel Hanford, Inc., Richland, Washington.
- HNF-SD-WM-TSR-006, Rev 0-1, *Tank Waste Remediation System Technical Safety Requirements*, 1997, Fluor Daniel Hanford, Inc., Richland, Washington.
- HSRCM-1, Rev. 2, *Hanford Site Radiological Control Manual*, U.S. Department of Energy, Washington, D.C.
- OSD-T-151-00007, *Unclassified Operation Specifications for the 241-AN, AP, AW, AY, AZ, & SY Tank Farms*, 1977, Fluor Daniel Hanford, Inc., Richland, Washington.
- OSD-T-151-00008-MISC, *Operating Specifications for the 204-AR Waste Unloading Facility*, 1996, Fluor Daniel Hanford, Inc., Richland Washington.
- Tri-Party Agreement, *Hanford Federal Facility Agreement and Consent Order*, as amended, Washington State Department of Ecology, U.S. Environmental Protection Agency, and the U.S. Department of Energy, Olympia, Washington.
- TWR-2244, Rev. 0, *Retrieved Waste Properties and High-Level Waste Critical Component Ratios for Prioritization Waste Feed Delivery*, 1998, Lockheed Martin Hanford Corporation for Fluor Daniel Hanford, Inc.
- WHC-CM-7-5, Release 90, *Environmental Compliance*, 1997, Westinghouse Hanford Company, Richland, Washington.
- WHC-EP-0182-99, *Waste Tank Summary Report for Month Ending June 30, 1996*, 1996, Westinghouse Hanford Company, Richland, Washington.
- WHC-SD-GN-ER-501, Rev. 0-A, *Natural Phenomena Hazards, Hanford Site, South-Central Washington*, 1996, Westinghouse Hanford Company, Richland, Washington.
- WHC-SD-WM-DQO-014, Rev. 1A, *242-A Evaporator/Liquid Effluent Retention Facility Data Quality Objectives*, 1995, Westinghouse Hanford Company, Richland, Washington.
- WHC-SD-WM-EV-053, Rev. 4, *Double-Shell Tank Waste Analysis Plan*, 1996, Westinghouse Hanford Company, Richland, Washington.

WHC-SD-WM-HSP-002, Rev. 2-F, *Tank Farm Health and Safety Plan*, 1996, Westinghouse Hanford Company, Richland, Washington.

WHC-SD-WM-OCD-015, Rev. 1, *Tank Waste Farm Transfer Compatibility Program*, 1995, Westinghouse Hanford Company, Richland, Washington.

WHC-SD-WM-SAR-023, Rev. 2-B, *242-A Evaporator/Crystallizer Safety Analysis Report*, 1997, Westinghouse Hanford Company, Richland, Washington.

**External Letters**

Letter, W. T. Alumkal, Westinghouse Hanford Company, to T. R. Sheridan, U.S. Department of Energy, Richland Operations Office, "Multi-Function Waste Tank Facility - Decision Paper," 9550111, dated January 13, 1995.

HNF-SD-WM-TRD-007  
Revision D

This page intentionally left blank.

## BASELINE COMPARISON OF DST SYSTEM SPECIFICATION TO W-211 FUNCTIONAL DESIGN CRITERIA

Based on DST System Specification: HNF-SD-WM-TRD-007, Rev. D, April, 1998 and W-211 Functional Design Criteria: HNF-SD-W211-FDC-001, Rev 3-A

**Purpose:** This activity is to identify shortcomings of the W-211 FDC based on the content of the DST system specification.

**Definition**  
**Risk:** The probability of significant consequences to the program without W-211 FDC revision.

**Legend**  
**N/A:** Not applicable. Either the requirement in the system specification is not within the W-211 work scope or the requirement in the W-211 FDC is not appropriate for inclusion in the system specification (e.g., the requirement is programmatic). Requirements for the top level (i.e., level 4) functions are marked N/A because they are at too high a level for comparison. The comparison will be performed at the level 5 functions only.

**No:** There is no comparable requirement in the W-211 FDC and a risk will be identified.

**Yes:** There are comparable or derivable requirements in the W-211 FDC and DST system specification, although minor differences may exist.

Shaded rows are for functions in the DST System specification. These functions are listed to provide the context for the performance requirements.

PARA. NUMBER	DST SYSTEM SPEC. REQUIREMENT	COMPARABLE/DERIVABLE REQUIREMENT			SECTION #	W-211 FDC REQUIREMENT	Notes
		N/A	No	Yes			
<b>3.2</b>	<b>SYSTEM CHARACTERISTICS</b>						
<b>3.2.1</b>	<b>Performance Characteristics</b>						
<b>3.2.1.1</b>	<b>Maintain Safe and Compliant Waste within the Double-Shell Tank System</b>						
3.2.1.1.a	DST System Storage Capacity, Phase I	X					Function is beyond W-211 scope.
3.2.1.1.b	DST System Spare Storage Capacity	X					Function is beyond W-211 scope.
<b>3.2.1.1.1</b>	<b>Store Waste in West Area Double-Shell Tanks</b>						
3.2.1.1.1.a	West Double Shell Tank System Storage Capacity, Phase I	X					Function is beyond W-211 scope
<b>3.2.1.1.2</b>	<b>Store Waste in East Area Double-Shell Tanks</b>						
3.2.1.1.2.a	East Double Shell Tank System Storage Capacity, Phase I	X					Function is beyond W-211 scope
<b>3.2.1.1.3</b>	<b>Transfer Waste from 204-AR Waste Unloading Station to East Area DSTs</b>						
3.2.1.1.3.a	204-AR Annual Capacity	X					Function is beyond W-211 scope.
3.2.1.1.3.b	204-AR Batch Transfer	X					Function is beyond W-211 scope.
3.2.1.1.3.c	204-AR Transferred Waste Properties	X					Function is beyond W-211 scope.
<b>3.2.1.1.4</b>	<b>Receive New Liquid Waste into West Area DSTs</b>						
3.2.1.1.4.a	West Area Liquid Waste Annual Capacity	X					Function is beyond W-211 scope.
3.2.1.1.4.b	Waste Batch Size – West Area	X					Function is beyond W-211 scope.
<b>3.2.1.1.5</b>	<b>Receive New Liquid Waste into East Area DSTs</b>						
3.2.1.1.5.a	East Area Liquid Waste Annual Capacity	X					Function is beyond W-211 scope.
3.2.1.1.5.b	Waste Batch Size – East Area						Function is beyond W-211 scope.
<b>3.2.1.1.6</b>	<b>Receive Concentrated Waste from Evaporator</b>						
3.2.1.1.6.a	Annual Volume of Concentrated Waste	X					Function is beyond W-211 scope.
3.2.1.1.6.b	Concentrated Waste Receipt Rate	X					Function is beyond W-211 scope.



## BASELINE COMPARISON OF DST SYSTEM SPECIFICATION TO W-211 FUNCTIONAL DESIGN CRITERIA

Based on DST System Specification: HNF-SD-WM-TRD-007, Rev. D, April, 1998 and W-211 Functional Design Criteria: HNF-SD-W211-FDC-001, Rev 3-A

PARA. NUMBER	DST SYSTEM SPEC. REQUIREMENT	COMPARABLE/DERIVABLE REQUIREMENT			SECTION #	W-211 FDC REQUIREMENT	Notes
		N/A	No	Yes			
3.2.1.1.7	Receive Emergency Purge from Evaporator						
3.2.1.1.7.a	Evaporator Purge Batch Size	X					Function is beyond W-211 scope.
3.2.1.1.8	Receive Waste Products from Low-Activity Waste/High-Level Waste and Low-Activity Waste Treatment						
3.2.1.1.8.a	Treatment Plant Waste Product Volume, Phase I	X					Function is beyond W-211 scope
3.2.1.1.8.b	Treatment Plant Waste Receipt Requirements	X					Function is beyond W-211 scope.
3.2.1.2	Remove Waste from Double-Shell Tanks, Phase I						
3.2.1.2.a	Low-Activity Waste Staging Quantity, Phase I	X					System level requirements too high for project comparison of the FDC.
3.2.1.2.b	Space Management Annual Waste Volume, Phase I	X					System level requirements too high for project comparison of the FDC.
3.2.1.2.c	Evaporator Feed Volume, Phase I	X					System level requirements too high for project comparison of the FDC.
3.2.1.2.d	Unretrieved Waste Properties			X	2.4.1	Mixer Pumps ( $U_0D$ )	Derivable. $U_0D$ is a measure of the energy being imparted into the waste to dissolve soluble waste and to retrieve insoluble waste.
3.2.1.2.1	Prepare Waste in West Area Double-Shell Tanks						
3.2.1.2.1.a	Supernatant Preparation – West Area			X	2.4.2	Transfer System (Diluent)	Based on the TWRS O&UP, the only adjustment will be to dilute the supernatant. The FDC requires the ability to add diluent.
3.2.1.2.1.a	Supernatant Preparation – West Area			X	2.4.3	Other Operating Rqmnts (Chemical Addition)	Based on the TWRS O&UP, the only adjustment will be to dilute the supernatant. The FDC requires the ability to add diluent.
3.2.1.2.1.b	Soluble Waste Preparation – West Area			X	2.4.2	Transfer System (Diluent)	Based on the TWRS O&UP, the only adjustment will be to add diluent to dissolve the soluble waste. The FDC requires the ability to add diluent.
3.2.1.2.1.b	Soluble Waste Preparation – West Area			X	2.4.3	Other Operating Rqmnts (Chemical Addition)	Based on the TWRS O&UP, diluent will be added to dissolve the soluble waste. The FDC requires the ability to add diluent.
3.2.1.2.1.b	Soluble Waste Preparation – West Area			X	2.4.3	Other Operating Rqmnts (Op. Cycle)	Operating cycle can be derived from time allocated for batch preparation.
3.2.1.2.1.c	Insoluble Waste Preparation – West Area			X	2.4.1	Mixer Pumps (Discharge Nozzle Height)	Derivable. Nozzle height is one parameter that will determine the ability to retrieve insoluble solids.
3.2.1.2.1.c	Insoluble Waste Preparation – West Area			X	2.4.1	Mixer Pumps (Nozzle Orientation)	Derivable. Nozzle orientation is one parameter that will determine the ability to retrieve insoluble solids.
3.2.1.2.1.c	Insoluble Waste Preparation – West Area			X	2.4.1	Mixer Pumps ( $U_0D$ )	Derivable. $U_0D$ is a measure of the energy being imparted into the waste to break up the insoluble waste.
3.2.1.2.1.c	Insoluble Waste Preparation – West Area			X	2.4.2	Transfer System (Diluent)	Based on the TWRS O&UP, diluent will be added to dilute the solids. The FDC requires the ability to add diluent.
3.2.1.2.1.c	Insoluble Waste Preparation – West Area			X	2.4.3	Other Operating Rqmnts (Chemical Addition)	Based on the TWRS O&UP, diluent will be added to dilute the solids. The FDC requires the ability to add diluent.
3.2.1.2.1.c	Insoluble Waste Preparation – West Area			X	2.4.3	Other Operating Rqmnts (Op. Cycle)	Operating cycle can be derived from time allocated for batch preparation.
3.2.1.2.2	Transfer Waste between West Area Double-Shell Tanks						
3.2.1.2.2.a	200 West Area Waste Batch Transfer			X	2.4.2	Transfer System (Velocity)	Both the batch transfer times in the specification and the velocity in the FDC are based on 140 gpm.
3.2.1.2.2.a	200 West Area Waste Batch Transfer			X	2.4.3	Other Operating Rqmnts (Op. Cycle)	Operating cycle can be derived from time allocated for batch transfer.
3.2.1.2.2.b	Waste Pumpability		X		2.4.2	Transfer System (Velocity)	FDC uses fluid velocity instead of Reynolds number. The W-211 systems will be capable of this flow at or below the specified viscosity. As the viscosity increases, the system may not be capable of maintaining the specified velocity. The specification allows higher viscosity

## BASELINE COMPARISON OF DST SYSTEM SPECIFICATION TO W-211 FUNCTIONAL DESIGN CRITERIA

Based on DST System Specification: HNF-SD-WM-TRD-007, Rev. D, April, 1998 and W-211 Functional Design Criteria: HNF-SD-W211-FDC-001, Rev 3-A

PARA. NUMBER	DST SYSTEM SPEC. REQUIREMENT	COMPARABLE/DERIVABLE REQUIREMENT			SECTION #	W-211 FDC REQUIREMENT	Notes
		N/A	No	Yes			
3.2.1.2.2.b	Waste Pumpability		X		2.4.2	Transfer System (Solids)	FDC has a requirement of 20% solids, not the 30% solids required by the specification. With the higher solids content, the pumps may not be capable of maintaining adequate flow.
3.2.1.2.2.b	Waste Pumpability			X	3.1.	Instrumentation & Control (Safe Operation & Failure)	Safe operation includes avoiding plugging of the transfer lines.
3.2.1.2.2.b	Waste Pumpability		X		3.3	Piping (Plugging Prevention)	FDC specifies line pluggage must be avoided.
3.2.1.2.3	Transfer Waste Cross-Site						
3.2.1.2.3.a	Cross-site Waste Transfer Time			X	2.4.2	Transfer System (Velocity)	Both the batch transfer times in the specification and the velocity in the FDC are based on 140 gpm.
3.2.1.2.3.a	Cross-site Waste Transfer Time			X	2.4.3	Other Operating Rqmnts (Op. Cycle)	Operating cycle can be derived from time allocated for batch transfer.
3.2.1.2.3.b	Waste Pumpability		X		2.4.2	Transfer System (Velocity)	FDC uses fluid velocity instead of Reynolds number. The W-211 systems will be capable of this flow at or below the specified viscosity. As the viscosity increases, the system may not be capable of maintaining the specified velocity. The specification allows higher viscosity.
3.2.1.2.3.b	Waste Pumpability		X		2.4.2	Transfer System (Solids)	FDC has a requirement of 20% solids, not the 30% solids required by the specification. With the higher solids content, the pumps may not be capable of maintaining adequate flow.
3.2.1.2.3.b	Waste Pumpability			X	3.1.	Instrumentation & Control (Safe Operation & Failure)	Safe operation includes avoiding plugging of the transfer lines.
3.2.1.2.4	Prepare Waste in East Area Double-Shell Tanks						
3.2.1.2.4.a	Supernatant Preparation – East Area			X	2.4.2	Transfer System (Diluent)	Based on the TWRS O&UP, the only adjustment will be to dilute the supernatant. The FDC requires the ability to add diluent.
3.2.1.2.4.a	Supernatant Preparation – East Area			X	2.4.3	Other Operating Rqmnts (Chemical Addition)	Based on the TWRS O&UP, the only adjustment will be to dilute the supernatant. The FDC requires the ability to add diluent.
3.2.1.2.4.b	Soluble Waste Preparation – East Area			X	2.4.2	Transfer System (Diluent)	Based on the TWRS O&UP, the only adjustment will be to add diluent to dissolve the soluble waste. The FDC requires the ability to add diluent.
3.2.1.2.4.b	Soluble Waste Preparation – East Area			X	2.4.3	Other Operating Rqmnts (Chemical Addition)	Based on the TWRS O&UP, diluent will be added to dissolve the soluble waste. The FDC requires the ability to add diluent.
3.2.1.2.4.b	Soluble Waste Preparation – East Area			X	2.4.3	Other Operating Rqmnts (Op. Cycle)	Operating cycle can be derived from time allocated for batch preparation.
3.2.1.2.4.c	Insoluble Waste Preparation – East Area			X	2.4.1	Mixer Pumps (Discharge Nozzle Height)	Derivable. Nozzle height is one parameter that will determine the ability to retrieve insoluble solids.
3.2.1.2.4.c	Insoluble Waste Preparation – East Area			X	2.4.1	Mixer Pumps (Nozzle Orientation)	Derivable. Nozzle orientation is one parameter that will determine the ability to retrieve insoluble solids.
3.2.1.2.4.c	Insoluble Waste Preparation – East Area			X	2.4.1	Mixer Pumps ( $U_0D$ )	Derivable. $U_0D$ is a measure of the energy being imparted into the waste to break up the insoluble waste.
3.2.1.2.4.c	Insoluble Waste Preparation – East Area			X	2.4.2	Transfer System (Diluent)	Based on the TWRS O&UP, diluent will be added to dilute the solids. The FDC requires the ability to add diluent.
3.2.1.2.4.c	Insoluble Waste Preparation – East Area			X	2.4.3	Other Operating Rqmnts (Chemical Addition)	Based on the TWRS O&UP, diluent will be added to dilute the solids. The FDC requires the ability to add diluent.
3.2.1.2.4.c	Insoluble Waste Preparation – East Area			X	2.4.3	Other Operating Rqmnts (Op. Cycle)	Operating cycle can be derived from time allocated for batch preparation.
3.2.1.2.5	Transfer Waste Between East Area Double-Shell Tanks						
3.2.1.2.5.a	200 East Area Waste Batch Transfer			X	2.4.2	Transfer System (Velocity)	Both the batch transfer times in the specification and the velocity in the FDC are based on 140 gpm.
3.2.1.2.5.a	200 East Area Waste Batch Transfer			X	2.4.3	Other Operating Rqmnts (Op. Cycle)	Operating cycle can be derived from time allocated for batch transfer.
3.2.1.2.5.b	Waste Pumpability		X		2.4.2	Transfer System (Velocity)	FDC uses fluid velocity instead of Reynolds number. The W-211 systems will be capable of this flow at or below the specified viscosity. As the viscosity increases, the system may not be capable of maintaining the specified velocity. The specification allows higher viscosity.

## BASELINE COMPARISON OF DST SYSTEM SPECIFICATION TO W-211 FUNCTIONAL DESIGN CRITERIA

Based on DST System Specification: HNF-SD-WM-TRD-007, Rev. D, April, 1998 and W-211 Functional Design Criteria: HNF-SD-W211-FDC-001, Rev 3-A

PARA. NUMBER	DST SYSTEM SPEC. REQUIREMENT	COMPARABLE/DERIVABLE REQUIREMENT			SECTION #	W-211 FDC REQUIREMENT	Notes
		N/A	No	Yes			
3.2.1.2.5.b	Waste Pumpability		X		2.4.2	Transfer System (Solids)	FDC has a requirement of 20% solids, not the 30% solids required by the specification. With the higher solids content, the pumps may not be capable of maintaining adequate flow.
3.2.1.2.5.b	Waste Pumpability			X	3.1	Instrumentation & Control (Safe Operation & Failure)	Safe operation includes avoiding plugging of the transfer lines.
3.2.1.2.6	Transfer Waste for Concentration						
3.2.1.2.6.a	Evaporator Feed Annual Volume	X					Function is beyond W-211 scope.
3.2.1.2.6.b	Evaporator Feed Rate	X					Function is beyond W-211 scope.
3.2.1.2.6.c	Evaporator Feed Requirements	X					Function is beyond W-211 scope.
3.2.1.2.6.d	Waste Pumpability			X	3.1	Instrumentation & Control (Safe Operation & Failure)	Safe operation includes avoiding plugging of the transfer lines.
3.2.1.2.7	Transfer Waste to Low-Activity Waste Staging Tanks						
3.2.1.2.7.a	Low-Activity Waste Staging Batch Volumes			X	2.4.2	Transfer System (Velocity)	Both the batch transfer times in the specification and the velocity in the FDC are based on 140 gpm.
3.2.1.2.7.a	Low-Activity Waste Staging Batch Volumes			X	2.4.3	Other Operating Rqmnts (Op. Cycle)	Operating cycle can be derived from time allocated for batch transfer.
3.2.1.2.7.b	Waste Pumpability		X		2.4.2	Transfer System (Velocity)	FDC uses fluid velocity instead of Reynolds number. The W-211 systems will be capable of this flow at or below the specified viscosity. As the viscosity increases, the system may not be capable of maintaining the specified velocity. The specification allows higher viscosity.
3.2.1.2.7.b	Waste Pumpability		X		2.4.2	Transfer System (Solids)	FDC has a requirement of 20% solids, not the 30% solids required by the specification. With the higher solids content, the pumps may not be capable of maintaining adequate flow.
3.2.1.2.7.b	Waste Pumpability			X	3.1	Instrumentation & Control (Safe Operation & Failure)	Safe operation includes avoiding plugging of the transfer lines.
3.2.1.3	Prepare Low-Activity Waste Feed for Phase I Treatment						
3.2.1.3.a	Low-Activity Waste Feed Composition and Physical Properties, Phase I	X					Operator will select waste to meet envelope composition requirements.
3.2.1.3.b	Waste Compatibility	X					Operator will select waste that satisfies compatibility requirements.
3.2.1.3.c	Low-Activity Waste Production Quantities, Phase I	X					System level requirements too high for project comparison of the FDC.
3.2.1.3.d	Low-Activity Waste Feed Frequency, Phase I	X					System level requirements too high for project comparison of the FDC.
3.2.1.3.1	Blend Low-Activity Waste in Low-Activity Waste Staging Tanks						
3.2.1.3.1.a	Low-Activity Waste Staging Batch Size, Phase I			X	2.4.1	Mixer Pumps (U <sub>2</sub> D)	U <sub>2</sub> D is a measure of the energy being imparted to mix the waste.
3.2.1.3.1.a	Low-Activity Waste Staging Batch Size, Phase I			X	2.4.3	Other Operating Rqmnts (Chemical Addition)	Based on the TWRS O&UP, diluent will be added to dilute the waste. The FDC requires the ability to add diluent.
3.2.1.3.1.a	Low-Activity Waste Staging Batch Size, Phase I			X	2.4.3	Other Operating Rqmnts (Op. Cycle)	Operating cycle can be derived from time allocated for blending.
3.2.1.3.1.a	Low-Activity Waste Staging Batch Size, Phase I			X	2.4.3	Other Operating Rqmnts (Sampling)	FDC requires maintaining existing provisions for sampling.
3.2.1.3.2	Transfer Low-Activity Waste Supernatants to Vendor Feed Storage						
3.2.1.3.2.a	Low-Activity Waste Batches, Phase I			X	2.4.2	Transfer System (Velocity)	Both the batch transfer times in the specification and the velocity in the FDC are based on 140 gpm.
3.2.1.3.2.a	Low-Activity Waste Batches, Phase I			X	2.4.3	Other Operating Rqmnts (Op. Cycle)	Operating cycle can be derived from time allocated for batch transfer.
3.2.1.3.2.b	Waste Pumpability		X		2.4.2	Transfer System (Velocity)	FDC uses fluid velocity instead of Reynolds number. The W-211 systems will be capable of this flow at or below the specified viscosity. As the viscosity increases, the system may not be capable of maintaining the specified velocity. The specification allows higher viscosity.

## BASELINE COMPARISON OF DST SYSTEM SPECIFICATION TO W-211 FUNCTIONAL DESIGN CRITERIA

Based on DST System Specification: HNF-SD-WM-TRD-007, Rev. D, April, 1998 and W-211 Functional Design Criteria: HNF-SD-W211-FDC-001, Rev 3-A

PARA. NUMBER	DST SYSTEM SPEC. REQUIREMENT	COMPARABLE/DERIVABLE REQUIREMENT			SECTION #	W-211 FDC REQUIREMENT	Notes
		N/A	No	Yes			
3.2.1.3.2.b	Waste Pumpability		X		2.4.2	Transfer System (Solids)	FDC has a requirement of 20% solids, not the 30% solids required by the specification. With the higher solids content, the pumps may not be capable of maintaining adequate flow.
3.2.1.3.2.b	Waste Pumpability			X	3.1.	Instrumentation & Control (Safe Operation & Failure)	Safe operation includes avoiding plugging of the transfer lines.
3.2.1.4	Prepare High-Level Waste Feed for Phase I Treatment						
3.2.1.4.a	High-Level Waste Feed Composition	X					Operator will select waste to meet envelope composition requirements.
3.2.1.4.b	High-Level Waste Feed Physical Properties	X					Operator will select waste that satisfies compatibility requirements.
3.2.1.4.c	High-Level Waste Production Quantities, Phase I	X					System level requirements too high for project comparison of the FDC.
3.2.1.4.d	High-Level Waste Feed Frequency, Phase I	X					System level requirements too high for project comparison of the FDC.
3.2.1.4.1	Perform Enhanced Sludge Washing (In-Tank)						
3.2.1.4.1.a	Sludge Wash Batch Volume			X	2.4.1	Mixer Pumps (U <sub>0</sub> D)	U <sub>0</sub> D is a measure of the energy being imparted to mix the waste so the wash can be completed within the allocated time.
3.2.1.4.1.b	High-Level Waste Sludge Washing Critical Component Ratios			X	2.4.1	Mixer Pumps (U <sub>0</sub> D)	U <sub>0</sub> D is a measure of the energy being imparted to mix the ratios can be achieved within the allocated time.
3.2.1.4.2	Transfer Sludge Wash Supernatants to East Double-Shell Tanks						
3.2.1.4.2.a	Sludge Wash Supernatant Total Volume	X					System level requirements too high for project comparison of the FDC.
3.2.1.4.2.b	Sludge Wash Supernatant Batch Volume			X	2.4.2	Transfer System (Velocity)	Both the batch transfer times in the specification and the velocity in the FDC are based on 140 gpm.
3.2.1.4.2.b	Sludge Wash Supernatant Batch Volume			X	2.4.3	Other Operating Rqmnts (Op. Cycle)	Operating cycle can be derived from time allocated for batch transfer.
3.2.1.4.2.c	Waste Pumpability		X		2.4.2	Transfer System (Velocity)	FDC uses fluid velocity instead of Reynolds number. The W-211 systems will be capable of this flow at or below the specified viscosity. As the viscosity increases, the system may not be capable of maintaining the specified velocity. The specification allows higher viscosity.
3.2.1.4.2.c	Waste Pumpability		X		2.4.2	Transfer System (Solids)	FDC has a requirement of 20% solids, not the 30% solids required by the specification. With the higher solids content, the pumps may not be capable of maintaining adequate flow.
3.2.1.4.2.c	Waste Pumpability			X	3.1.	Instrumentation & Control (Safe Operation & Failure)	Safe operation includes avoiding plugging of the transfer lines.
3.2.1.4.3	Prepare High-Level Waste Solids						
3.2.1.4.3.a	High-Level Waste Batch Sizes, Phase I			X	2.4.1	Mixer Pumps (U <sub>0</sub> D)	U <sub>0</sub> D is a measure of the energy being imparted to mix the waste.
3.2.1.4.3.b	High-Level Waste Preparation, Phase I			X	2.4.1	Mixer Pumps (U <sub>0</sub> D)	U <sub>0</sub> D is a measure of the energy being imparted to mix the waste.
3.2.1.4.4	Transfer High-Level Waste Sludge to Low Activity Waste/High-Level Waste Plant						
3.2.1.4.4.a	High-Level Waste Batch Transfer Volume			X	2.4.2	Transfer System (Velocity)	Both the batch transfer times in the specification and the velocity in the FDC are based on 140 gpm.
3.2.1.4.4.a	High-Level Waste Batch Transfer Volume			X	2.4.3	Other Operating Rqmnts (Op. Cycle)	Operating cycle can be derived from time allocated for batch transfer.
3.2.1.4.4.b	Waste Pumpability		X		2.4.2	Transfer System (Velocity)	FDC uses fluid velocity instead of Reynolds number. The W-211 systems will be capable of this flow at or below the specified viscosity. As the viscosity increases, the system may not be capable of maintaining the specified velocity. The specification allows higher viscosity.
3.2.1.4.4.b	Waste Pumpability		X		2.4.2	Transfer System (Solids)	FDC has a requirement of 20% solids, not the 30% solids required by the specification. With the higher solids content, the pumps may not be capable of maintaining adequate flow.

## BASELINE COMPARISON OF DST SYSTEM SPECIFICATION TO W-211 FUNCTIONAL DESIGN CRITERIA

Based on DST System Specification: HNF-SD-WM-TRD-007, Rev. D, April, 1998 and W-211 Functional Design Criteria: HNF-SD-W211-FDC-001, Rev 3-A

PARA. NUMBER	DST SYSTEM SPEC. REQUIREMENT	COMPARABLE/DERIVABLE REQUIREMENT			SECTION #	W-211 FDC REQUIREMENT	Notes
		N/A	No	Yes			
3.2.1.4.b	Waste Pumpability			X	3.1.	Instrumentation & Control (Safe Operation & Failure)	Safe operation includes avoiding plugging of the transfer lines.
3.2.1.5	Characterize DST Waste						
3.2.1.5.a	DST System Waste Characterization Requirements	X			2.4.3	Other Operating Rqmnts (Sampling)	Function is beyond W-211 scope. FDC requires maintenance of existing capability.
3.2.1.5.a	DST System Waste Characterization Requirements	X					Function is beyond W-211 scope.
3.2.1.6	Distribute Utilities in Double-Shell Tank System						
3.2.1.7	Support Double-Shell Tank System						
3.2.3	External Interface Requirements						
3.2.3.1	External Waste Generators Using Surface Transport						
3.2.3.1.a	204-AR Waste Receipt Properties	X					Function is beyond W-211 scope.
3.2.3.2	Plutonium Finishing Plant (PFP)						
3.2.3.2.a	Plutonium Finishing Plant Waste Annual Volume	X					Function is beyond W-211 scope.
3.2.3.2.b	Plutonium Finishing Plant Waste Properties	X					Function is beyond W-211 scope.
3.2.3.3	S Plant						
3.2.3.3.a	S Plant Waste Volume	X					Function is beyond W-211 scope.
3.2.3.3.b	S Plant Waste Properties	X					Function is beyond W-211 scope.
3.2.3.4	B Plant/Waste Encapsulation and Storage Facility (WESF)						
3.2.3.4.a	B Plant/Waste Encapsulation and Storage Facility Waste Volume	X					Function is beyond W-211 scope.
3.2.3.4.b	B Plant/Waste Encapsulation and Storage Facility Waste Properties	X					Function is beyond W-211 scope.
3.2.3.5	Single-Shell Tank System						
3.2.3.5.a	West Single-Shell Tank Salt Well Liquid Waste Volume	X					Function is beyond W-211 scope.
3.2.3.5.b	East Single-Shell Tank Salt Well Liquid Waste Volume	X					Function is beyond W-211 scope.
3.2.3.5.c	Single-Shell Tank Salt Well Liquid Waste Properties	X					Function is beyond W-211 scope.
3.2.3.5.d	Single-Shell Tank Waste Retrieval Volume, Phase I	X					Function is beyond W-211 scope.
3.2.3.6	Evaporator						
3.2.3.6.a	Concentrated Waste Receipt Rate	X					Function is beyond W-211 scope.
3.2.3.6.b	Concentrated Waste Composition	X					Function is beyond W-211 scope.
3.2.3.6.c	Emergency Transfer Volume from Evaporator	X					Function is beyond W-211 scope.
3.2.3.7	Phase I Low-Activity Waste Plant						
3.2.3.7.a	Low-Activity Waste Plant Entrained Solids Total Volume	X					Function is beyond W-211 scope.
3.2.3.7.b	Entrained Solids Batch Volume Requirements	X					Function is beyond W-211 scope.
3.2.3.7.c	Entrained Solids Physical Properties	X					Function is beyond W-211 scope.
3.2.3.7.d	Waste Product Sodium Content	X					Function is beyond W-211 scope.
3.2.3.7.e	Entrained Solids Cesium-137 Content	X					Function is beyond W-211 scope.
3.2.3.7.f	Entrained Solids Technetium-99 Content	X					Function is beyond W-211 scope.
3.2.3.7.g	Plutonium Content	X					Function is beyond W-211 scope.
3.2.3.7.h	Separable Organics	X					Function is beyond W-211 scope.

## BASELINE COMPARISON OF DST SYSTEM SPECIFICATION TO W-211 FUNCTIONAL DESIGN CRITERIA

Based on DST System Specification: HNF-SD-WM-TRD-007, Rev. D, April, 1998 and W-211 Functional Design Criteria: HNF-SD-W211-FDC-001, Rev 3-A

PARA. NUMBER	DST SYSTEM SPEC. REQUIREMENT	COMPARABLE/DERIVABLE REQUIREMENT			SECTION #	W-211 FDC REQUIREMENT	Notes
		N/A	No	Yes			
3.2.3.7.i	Scaling	X					Function is beyond W-211 scope.
3.2.3.7.j	Stability Prevention of Exothermic Reaction	X					Function is beyond W-211 scope.
3.2.3.7.k	Immobilized High-Level Waste Impacts	X					Function is beyond W-211 scope.
3.2.3.7.l	Waste Pumpability			X	3.1.	Instrumentation & Control (Safe Operation & Failure)	Safe operation includes avoiding plugging of the transfer lines.
3.2.3.7.l	Waste Pumpability	X					Function is beyond W-211 scope.
3.2.3.8	Phase I Low-Activity Waste/High-Level Waste Plant						
3.2.3.8.a	Entrained Solids Total Volume	X					Function is beyond W-211 scope.
3.2.3.8.b	Entrained Solids Properties	X					Function is beyond W-211 scope.
3.2.3.9	Central Plateau Electrical System						
3.2.3.10	Central Plateau Water System						
3.2.5	System Quality Factors						
3.2.5.1	Reliability, Availability, Maintainability		X		2.3.2	Degree of Reliability	DST System requirement hard to interpret. FDC doesn't address all important aspects of RAM (e.g., time constraints for pump replacement).
3.2.5.1	Reliability, Availability, Maintainability		X		2.4.1	Mixer Pumps (Monitoring)	It is assumed that this instrumentation would be used for predictive maintenance to provide high reliability and availability.
3.2.5.1	Reliability, Availability, Maintainability		X		2.4.3	Other Operating Rqmnts (Single Failure)	DST System requirement hard to interpret. FDC doesn't address all important aspects of RAM (e.g., time constraints for pump replacement).
3.2.5.1	Reliability, Availability, Maintainability		X		2.4.4	Services (Electrical)	FDC identifies need for safety analysis to determine the reliability and availability necessary for nuclear safety. This will determine the need for standby and/or uninterruptable power.
3.2.5.1	Reliability, Availability, Maintainability		X		2.4.5	Maintenance Rqmnts (Ease of Maintenance.)	DST System requirement hard to interpret. FDC doesn't address all important aspects of RAM (e.g., time constraints for pump replacement).
3.2.5.1	Reliability, Availability, Maintainability		X		2.4.5	Maintenance Rqmnts. (Equipment Access)	DST System requirement hard to interpret. FDC doesn't address all important aspects of RAM (e.g., time constraints for pump replacement).
3.2.5.1	Reliability, Availability, Maintainability		X		2.4.5	Maintenance Rqmnts. (Facility /Equipment Layout)	DST System requirement hard to interpret. FDC doesn't address all important aspects of RAM (e.g., time constraints for pump replacement).
3.2.5.1	Reliability, Availability, Maintainability		X		2.4.5	Maintenance Rqmnts. (In Situ Maintenance & Calibration)	DST System requirement hard to interpret. FDC doesn't address all important aspects of RAM (e.g., time constraints for pump replacement).
3.2.5.1	Reliability, Availability, Maintainability		X		3.1	Instrumentation & Control (Maintenance)	FDC doesn't contain calibration requirements.
3.2.5.1	Reliability, Availability, Maintainability		X		3.1	Instrumentation & Control (Repair)	FDC doesn't contain calibration requirements.
3.2.5.1	Reliability, Availability, Maintainability		X		3.3	Piping (Plugging Prevention)	Comparable if piping is sized to obtain the specified Reynolds Number.
3.2.5.1	Reliability, Availability, Maintainability		X		3.4.	Gen. Mech. Process (Single Failure)	DST System requirement hard to interpret. FDC doesn't address all important aspects of RAM (e.g., time constraints for pump replacement).
3.2.5.1	Reliability, Availability, Maintainability		X		4.8.1	Maintenance Facility (Cost Effective)	DST System requirement hard to interpret. FDC doesn't address all important aspects of RAM (e.g., time constraints for pump replacement).
3.2.5.1	Reliability, Availability, Maintainability		X		4.8.2	Maintenance Equipment (Radiation Protection)	DST System requirement hard to interpret. FDC doesn't address all important aspects of RAM (e.g., time constraints for pump replacement).
3.2.5.1	Reliability, Availability, Maintainability		X		4.8.2	Maintenance Equipment (RAM)	DST System requirement hard to interpret. FDC doesn't address all important aspects of RAM (e.g., time constraints for pump replacement).
3.2.5.2	Design Life			X	2.3.1	Design Life (Permanent Modifications)	Should be derivable from specification design life.
3.2.5.2	Design Life			X	2.3.1	Design Life (Pumps)	Should be derivable from specification design life.
3.2.5.2	Design Life			X	2.3.1	Design Life (Replaceable Equipment)	Should be derivable from specification design life.
3.2.5.2	Design Life			X	2.4.9	Monitoring System (Camera Life)	Should be derivable from specification design life.
3.2.5.2.1	Design Life			X	3.2.	Electrical (Design Life)	Should be derivable from specification design life.
3.2.6	Environmental Conditions						

## BASELINE COMPARISON OF DST SYSTEM SPECIFICATION TO W-211 FUNCTIONAL DESIGN CRITERIA

Based on DST System Specification: HNF-SD-WM-TRD-007, Rev. D, April, 1998 and W-211 Functional Design Criteria: HNF-SD-W211-FDC-001, Rev 3-A

PARA. NUMBER	DST SYSTEM SPEC. REQUIREMENT	COMPARABLE/DERIVABLE REQUIREMENT			SECTION #	W-211 FDC REQUIREMENT	Notes
		N/A	No	Yes			
3.2.6.1	Environmental Conditions		X		2.3.3	Operating Environment (Ambient Conditions)	FDC reference GH-CLIM-01 which is only for HVAC design. This document doesn't include some environmental conditions (e.g., solar radiation, dust, and soil temperatures) and defines less conservative extremes.
3.2.6.1	Environmental Conditions			X	2.4.8	Waste Tank/Equip. Loading (Natural Loads)	Natural loads are comparable.
3.2.6.1	Environmental Conditions		X		3.1.	Instrumentation & Control (Environment)	In section 2.3.3, FDC references GH-CLIM-01 which is only for HVAC design. This document doesn't include some environmental conditions (e.g., solar radiation, dust, and soil temperatures) and defines less conservative extremes.
3.2.6.1	Environmental Conditions		X		3.2.	Electrical (Environmental Conditions)	In section 2.3.3, FDC references GH-CLIM-01 which is only for HVAC design. This document doesn't include some environmental conditions (e.g., solar radiation, dust, and soil temperatures) and defines less conservative extremes.
3.2.6.1	Environmental Conditions		X		3.4	Gen. Mech. Process (Elastomers)	In section 2.3.3, FDC references GH-CLIM-01 which is only for HVAC design. This document doesn't include some environmental conditions (e.g., solar radiation, dust, and soil temperatures) and defines less conservative extremes.
3.2.6.1	Environmental Conditions			X	4.4.1	Water (Buried Water Lines)	FDC requires burial of water lines to prevent freezing. DST specification provides subsurface soil temperature data.
3.2.6.1	Environmental Conditions			X	5.4.1	Design Basis Earthquake	Natural loads are comparable.
3.2.6.1	Environmental Conditions			X	5.4.2	Design Basis Wind	Natural loads are comparable.
3.2.6.1	Environmental Conditions	X			5.4.3	Design Basis Flood	Both documents say DST System is outside flood plane.
3.2.6.1	Environmental Conditions			X	5.4.4	Volcanic Eruptions	Natural loads are comparable.
3.2.6.1	Environmental Conditions						
3.2.6.2	Chemical				2.3.3, 2.4.1, & 2.4.2	Operating Environment (General Chemical)	FDC requires equipment to be compatible with waste properties. The project is using the TCRs to define tank chemical properties. The TCRs are comparable to the best basis inventory.
3.2.6.2	Chemical				2.4.2	Transfer Sys. (General Chemical)	FDC requires equipment to be compatible with waste properties. The project is using the TCRs to define tank chemical properties. The TCRs are comparable to the best basis inventory.
3.2.6.2	Chemical				2.4.10	Materials (Chemical Compatibility)	FDC requires equipment to be compatible with waste properties. The project is using the TCRs to define tank chemical properties. The TCRs are comparable to the best basis inventory.
3.2.6.2	Chemical				3.1.	Instrumentation & Control (Safe Operation & Failure)	FDC requires equipment to be compatible with waste properties. The project is using the TCRs to define tank chemical properties. The TCRs are comparable to the best basis inventory.
3.2.6.2	Chemical				3.2.	Electrical (Environmental Conditions)	FDC requires equipment to be compatible with waste properties. The project is using the TCRs to define tank chemical properties. The TCRs are comparable to the best basis inventory.
3.2.6.2	Chemical				3.4	Gen. Mech. Process (Elastomers)	FDC requires equipment to be compatible with waste properties. The project is using the TCRs to define tank chemical properties. The TCRs are comparable to the best basis inventory.
3.2.6.3	Radiation		X		2.3.3	Operating Environment (General Radiation)	FDC maximum is 500 R/hr. DST System specification radiation level in tanks goes up to 1,000 R/hr.
3.2.6.3	Radiation		X		2.3.3 & 2.4.9	Operating Environment (Camera Radiation)	FDC maximum is 500 R/hr. DST System specification radiation level in tanks goes up to 1,000 R/hr.
3.2.6.3	Radiation		X		2.4.1	Mixer Pumps (Integrated Dose)	Integrated dose in the FDC is based on 2.2E07 rad. DST System specification maximum integrated dose (for AY-101) is 9.5E07rad.
3.2.6.3	Radiation		X		2.4.2	Transfer System (Integrated Dose)	Integrated dose in the FDC is based on 2.2E07 rad. DST System specification maximum integrated dose (for AY-101) is 9.5E07rad.
3.2.6.3	Radiation		X		2.4.10	Materials (Radiation Compatibility)	Integrated dose in the FDC is based on 2.2E07 rad. DST System specification maximum integrated dose (for AY-101) is 9.5E07rad.
3.2.6.3	Radiation		X		3.1.	Instrumentation & Control (Safe Operation & Failure)	Integrated dose in the FDC is based on 2.2E07 rad. DST System specification maximum integrated dose (for AY-101) is 9.5E07rad.

## BASELINE COMPARISON OF DST SYSTEM SPECIFICATION TO W-211 FUNCTIONAL DESIGN CRITERIA

Based on DST System Specification: HNF-SD-WM-TRD-007, Rev. D, April, 1998 and W-211 Functional Design Criteria: HNF-SD-W211-FDC-001, Rev 3-A

PARA. NUMBER	DST SYSTEM SPEC. REQUIREMENT	COMPARABLE/DERIVABLE REQUIREMENT			SECTION #	W-211 FDC REQUIREMENT	Notes
		N/A	No	Yes			
3.2.6.3	Radiation		X		3.2.	Electrical (Environmental Conditions)	Integrated dose in the FDC is based on 2.2E07 rad. DST System specification maximum integrated dose (for AY-101) is 9.5E07rad.
3.2.6.3	Radiation		X		3.4	Gen. Mech. Process (Elastomers)	Integrated dose in the FDC is based on 2.2E07 rad. DST System specification maximum integrated dose (for AY-101) is 9.5E07rad.
3.2.7	Transportability			X	2.4.6	Shipping & Handling (Solid Waste Disposal Containers)	FDC uses WHC-CM-2-14 which has been replaced by HNF-PRO-157 which is used in the system specification
3.2.7	Transportability			X	2.4.6	Shipping & Handling (Waste Containment)	Containment of waste is part of packaging and shipping.
3.2.8	Flexibility and Expansion			X	3.1.	Instrumentation & Control (Expansion)	FDC requires ability to expand I&C system.
3.2.8	Flexibility and Expansion			X	3.4	Gen. Mech. Process (Commercial Parts)	Use of commercial parts will provide a degree of flexibility.
3.2.8	Flexibility and Expansion			X	6.3	U. S. Department of Energy Orders	Both invoke DOE Order 6430.1A.
3.3	Design and Construction			X	3.3.	Piping (Consensus Standards)	DOE Order 6430.1A invokes these standards
3.3	Design and Construction			X	4.4.2	Instrument Air (Consensus Standards)	DOE Order 6430.1A invokes these standards
3.3	Design and Construction			X	4.4.3	Electrical (Consensus Standards)	DOE Order 6430.1A invokes these standards
3.3	Design and Construction			X	4.5.	Lighting (Consensus Standards)	DOE Order 6430.1A invokes these standards
3.3	Design and Construction			X	4.6	Structural (Consensus Standards)	DOE Order 6430.1A invokes these standards
3.3	Design and Construction			X	4.7.	Energy Conservation (Consensus Standards)	Both invoke DOE Order 6430.1A.
3.3	Design and Construction			X	4.8.1	Facility (Maintenance Requirements)	Both invoke DOE Order 6430.1A.
3.3	Design and Construction			X	6.1	Requirements Documents (Consensus Standards)	DOE Order 6430.1A invokes these standards
3.3	Design and Construction			X	6.3	U. S. Department of Energy Orders	Both invoke DOE Order 6430.1A.
3.3.1	Materials, Processes, and Design Practices						
3.3.1.1	Toxic Products and Formulations			X	5.1.6	Industrial Safety/Hygiene (Hazardous, Material)	FDC has more conservative requirements for the hazardous materials within it's scope.
3.3.1.1	Toxic Products and Formulations			X	5.9	Waste Min. & Hazardous Material Usage (Encapsulation)	FDC has more conservative requirements for the hazardous materials within it's scope.
3.3.1.1	Toxic Products and Formulations			X	5.9	Waste Min. & Hazardous Material Usage (Regulated)	FDC has more conservative requirements for the hazardous materials within it's scope.
3.3.1.2	Dangerous Waste			X	2.4.3 & 6.4	Other Operating Rqmnts (Decontamination Fluid Disposal)	FDC requirement can be derived from system requirement.
3.3.1.2	Dangerous Waste			X	2.4.6	Shipping & Handling (Decontamination Solution Compatibility)	FDC requirement can be derived from system requirement.
3.3.1.2	Dangerous Waste			X	5.9	Waste Min. & Hazardous Material Usage (Regulated)	FDC has more conservative requirements for the hazardous materials within it's scope.
3.3.1.2	Dangerous Waste			X	6.3	U. S. Department of Energy Orders	Both invoke WAC-173-303.
3.3.1.3	Decontamination & Decommissioning			X	2.4.1	Mixer Pumps (Pump Decontamination)	Design details can be derived from system requirement.
3.3.1.3	Decontamination and Decommissioning			X	5.1.3	Contamination Control (Decontamination)	Both require provisions for decontamination.
3.3.1.3	Decontamination and Decommissioning			X	5.8	Decontamination and Decommissioning	Derivable from system requirement.
3.3.1.1	Computer Resource Reserve Capacity	X					Requirement is beyond W-211 scope.
3.3.2	Electromagnetic Radiation		X		3.1.	Instrumentation & Control (EMI)	FDC requires separation of power and control wiring, but doesn't deal with other EMI requirements.
3.3.3	Nameplates and Product Markings			X	2.4.6	Shipping & Handling (Marking)	Both invoke requirement in DOE Order 6430.1A.
3.3.5	Interchangeability		X		3.4	Gen. Mech. Process (Commercial Parts)	FDC doesn't address interchangeability requirements.
3.3.6	Safety						
3.3.6.1.1	Occupational Radiological Protection			X	2.4.1 & 3.4	Mixer Pumps (Safety Interlocks)	"Safety" interlocks are required for personnel safety.
3.3.6.1.1	Occupational Radiological Protection			X	2.4.3	Other Operating Rqmnts (ALARA)	Both require application of ALARA.
3.3.6.1.1	Occupational Radiological Protection			X	2.4.6	Shipping & Handling (Radiation Protection)	Both require limiting of personnel dose rates.
3.3.6.1.1	Occupational Radiological Protection			X	3.1.	Instrumentation & Control (Radiation Monitoring)	Instrumentation requirements can be derived from HSRM-1.
3.3.6.1.1	Occupational Radiological Protection			X	3.3.	Piping (Siphoning & Backflow Prevention.)	FDC requirements limit personnel exposure.
3.3.6.1.1	Occupational Radiological Protection			X	4.2	Civil (ALARA)	Both require application of ALARA.
3.3.6.1.1	Occupational Radiological Protection			X	4.4.1	Water (Backflow Prevention)	FDC requirements limit personnel exposure.
3.3.6.1.1	Occupational Radiological Protection			X	4.8.1	Facility (ALARA)	Both require application of ALARA.
3.3.6.1.1	Occupational Radiological Protection			X	4.8.2	Equipment (Radiation Protection)	FDC requirements limit personnel exposure.
3.3.6.1.1	Occupational Radiological Protection			X	5.1.	Safety (ALARA)	Both require application of ALARA.
3.3.6.1.1	Occupational Radiological Protection			X	5.1.2.1	Design Basis Accidents (Safety Analysis)	Both require safety analysis using design basis accidents.



## BASELINE COMPARISON OF DST SYSTEM SPECIFICATION TO W-211 FUNCTIONAL DESIGN CRITERIA

Based on DST System Specification: HNF-SD-WM-TRD-007, Rev. D, April, 1998 and W-211 Functional Design Criteria: HNF-SD-W211-FDC-001, Rev 3-A

PARA. NUMBER	DST SYSTEM SPEC. REQUIREMENT	COMPARABLE/DERIVABLE REQUIREMENT			SECTION #	W-211 FDC REQUIREMENT	Notes	F
		N/A	No	Yes				
3.3.6.1.1	Occupational Radiological Protection			X	5.1.2.2	Component Failure Analysis (Radiation Protection)	Both reference HSRCM-1.	
3.3.6.1.1	Occupational Radiological Protection			X	5.1.4	Shielding (ALARA)	Both require application of ALARA.	
3.3.6.1.1	Occupational Radiological Protection			X	5.1.5.1	General Radiation, Protection (Radiation Alarms)	Alarms are required for personnel safety.	
3.3.6.1.1	Occupational Radiological Protection			X	5.1.5.2	Radiation, Protection Optimization (ALARA)	Both require application of ALARA.	
3.3.6.1.1	Occupational Radiological Protection			X	5.1.5.3	Control of Occupational Ext. Radiation, Exposure (ALARA)	Both require application of ALARA.	
3.3.6.1.1	Occupational Radiological Protection			X	5.1.5.4	Control of Occupational Int. Radiation, Exposure (Radiation Protection)	Derivable requirement for personnel safety.	
3.3.6.1.1	Occupational Radiological Protection			X	5.1.8	Abnormal Operations	Both require safety analysis using design basis accidents.	
3.3.6.1.1	Occupational Radiological Protection			X	5.4.5	Design Basis Power Failure	Both require safety analysis using design basis accidents.	
3.3.6.1.1	Occupational Radiological Protection			X	6.2	U.S. Code of Federal Regulations (Radiation Protection)	Requirements of 10 CFR 835 are satisfied by HSRCM-1.	
3.3.6.1.2	Occupational Safety and Health Standards (OSHA)			X	2.4.1 & 3.4	Mixer Pumps (Safety Interlocks)	"Safety" interlocks are required for personnel safety.	
3.3.6.1.2	Occupational Safety and Health Standards (OSHA)			X	2.4.3	Other Operating Rqmnts (Remote Operation)	Neither document contains operation and maintenance concepts.	
3.3.6.1.2	Occupational Safety and Health Standards (OSHA)			X	2.4.4	Services (Hoisting Hardware)	FDC requirements can be derived from system requirement.	
3.3.6.1.2	Occupational Safety and Health Standards (OSHA)			X	3.3.	Piping (Siphoning & Backflow Prevention.)	FDC requirements can be derived from system requirement.	
3.3.6.1.2	Occupational Safety and Health Standards (OSHA)			X	4.8.2	Equipment (Grounding)	FDC requirements can be derived from system requirement.	
3.3.6.1.2	Occupational Safety and Health Standards (OSHA)			X	5.1.	Safety (Safety Analysis)	FDC requirements can be derived from system requirement.	
3.3.6.1.2	Occupational Safety and Health Standards (OSHA)			X	5.1.4	Shielding (ALARA)	Both require application of ALARA.	
3.3.6.1.2	Occupational Safety and Health Standards (OSHA)			X	5.1.8	Industrial Safety/Hygiene (Hazardous, Material)	FDC has more conservative requirements for the hazardous materials within it's scope.	
3.3.6.1.2	Occupational Safety and Health Standards (OSHA)			X	5.1.8	Abnormal Operations	Both require analysis using design basis accidents.	
3.3.6.1.2	Occupational Safety and Health Standards (OSHA)			X	5.1.9	Traffic Safety	Traffic flow during an emergency is an OSHA consideration.	
3.3.6.1.2	Occupational Safety and Health Standards (OSHA)			X	5.4.5	Design Basis Power Failure	Both require analysis using design basis accidents.	
3.3.6.1.2	Occupational Safety and Health Standards (OSHA)			X	5.4.6	Design Basis Fire	Both require analysis using design basis accidents.	
3.3.6.1.2	Occupational Safety and Health Standards (OSHA)			X	5.9	Waste Min. & Hazardous Material Usage (MSDS)	MSDS sheets are an OSHA requirement.	
3.3.6.1.2	Occupational Safety and Health Standards (OSHA)			X	6.1	Requirements Documents (OSHA)	Both require compliance with OSHA.	
3.3.6.1.2	Occupational Safety and Health Standards (OSHA)			X	6.2	U.S. Code of Federal Regulations (OSHA)	Both require compliance with OSHA.	
3.3.6.2	Occupational Radiological Protection			X	3.4.	Gen. Mech. Process (Safe Failure)	Safe failure is part of occupational radiological protection.	
3.3.6.2.1	System Safety			X	3.3.	Piping (Cathodic Protection)	Both require corrosion protection.	
3.3.6.2.1	Corrosion Prevention and Control			X	3.3.	Piping (Cathodic Protection)	Both require corrosion protection.	
3.3.6.2.3	Tank Temperature Limits			X	2.4.1	Mixer Pumps (Variable Speed)	Derivable. The variable speed drives a low operation with the lowest possible heat input and, thus, maximizes run time without exceeding the temperature limits.	
3.3.6.2.3	Tank Temperature Limits			X	2.4.1 & 2.4.2	Mixer Pumps (Waste Temperature)	Both require staying within temperature limits.	
3.3.6.2.3	Tank Temperature Limits			X	2.4.1 & 3.4	Mixer Pumps (Safety Interlocks)	"Safety" interlocks are required for system safety.	
3.3.6.2.3	Tank Temperature Limits			X	2.4.7	Thermal Considerations (Added Heat)	Both require staying within temperature limits.	
3.3.6.2.3	Tank Temperature Limits			X	3.1.	Instrumentation & Control (Safe Operation & Failure)	System safety requires staying within temperature limits.	

## BASELINE COMPARISON OF DST SYSTEM SPECIFICATION TO W-211 FUNCTIONAL DESIGN CRITERIA

Based on DST System Specification: HNF-SD-WM-TRD-007, Rev. D, April, 1998 and W-211 Functional Design Criteria: HNF-SD-W211-FDC-001, Rev 3-A

PARA. NUMBER	DST SYSTEM SPEC. REQUIREMENT	COMPARABLE/DERIVABLE REQUIREMENT			SECTION #	W-211 FDC REQUIREMENT	Notes
		N/A	No	Yes			
3.3.6.2.4	Dome/Vault Loading			X	2.4.8	Waste Tank/Equip. Loading (Induced Loads)	Both limit induced loading.
3.3.6.2.5	Dome/Vault Loading			X	2.4.1	Mixer Pumps (Support)	Both limit induced loading.
3.3.6.3	Environmental Safety (All Sections)			X	3.4.	Gen. Mech. Process (Safe Failure)	Both require protection of the public and environment after a failure.
3.3.6.3.1	Secondary Containment and Leak Detection			X	2.4.1	Mixer Pumps (Waste Containment)	Both require waste containment.
3.3.6.3.1	Secondary Containment and Leak Detection			X	2.4.3	Other Operating Rqmnts (Leak Containment)	Both require waste containment.
3.3.6.3.1	Secondary Containment and Leak Detection			X	2.4.3	Other Operating Rqmnts (Leak Containment)	Both require waste containment.
3.3.6.3.1	Secondary Containment and Leak Detection			X	3.1.	Instrumentation & Control (Confinement)	Both require waste containment.
3.3.6.3.1	Secondary Containment and Leak Detection			X	3.1.	Instrumentation & Control (Safe Operation & Failure)	Both require waste containment.
3.3.6.3.1	Secondary Containment and Leak Detection			X	3.3.	Piping (Secondary Containment)	Both require waste containment.
3.3.6.3.1	Secondary Containment and Leak Detection			X	5.1.3	Contamination Control (Containment)	Both require waste containment.
3.3.6.3.1	Secondary Containment and Leak Detection			X	5.2	Environmental Protection	Both require waste containment.
3.3.6.3.1	Secondary Containment and Leak Detection			X	6.3	U.S. Department of Energy Orders (Environmental Protection)	Both require waste containment.
3.3.6.3.2	Spill Prevention and Controls			X	2.4.3	Other Operating Rqmnts (Level & Pressure)	Level monitoring is part of spill prevention.
3.3.6.3.2	Spill Prevention and Controls			X	3.1.	Instrumentation & Control (Safe Operation & Failure)	The system must contain waste during design basis events.
3.3.6.3.2	Spill Prevention and Controls			X	3.3	Piping (Overflow and Pressurization)	The system must contain waste during design basis events.
3.3.6.3.2	Spill Prevention and Controls			X	5.2.	Environmental Protection	The system must contain waste during design basis events.
3.3.6.3.3	Non-radioactive Airborne Emissions			X	2.4.1 & 3.4	Mixer Pumps (Safety Interlocks)	"Safety" interlocks are required for environmental protection.
3.3.6.3.3	Non-radioactive Airborne Emissions			X	3.1.	Instrumentation & Control (Safe Operation & Failure)	Airborne emissions must be limited during operation and system failures.
3.3.6.3.3	Non-radioactive Airborne Emissions			X	4.3.	Ventilation (Tank Pressure)	Tank pressure will be maintained negative to control airborne emissions
3.3.6.3.3	Non-radioactive Airborne Emissions			X	5.2.	Environmental Protection	The system must contain waste during design basis events.
3.3.6.3.4	Radioactive Airborne Emissions			X	2.4.1 & 3.4	Mixer Pumps (Safety Interlocks)	"Safety" interlocks are required for environmental protection.
3.3.6.3.4	Radioactive Airborne Emissions			X	3.1.	Instrumentation & Control (Safe Operation & Failure)	Airborne emissions must be limited during operation and system failures.
3.3.6.3.4	Radioactive Airborne Emissions			X	4.3.	Ventilation (Tank Pressure)	Pressure monitoring is part of preventing airborne emissions.
3.3.6.3.4	Radioactive Airborne Emissions			X	5.1.3	Contamination Control (HVAC)	HEPA filtration and release monitoring is part of preventing airborne emissions.
3.3.6.3.4	Radioactive Airborne Emissions			X	5.2.	Environmental Protection	The system must contain waste during design basis events.
3.3.6.3.5	Monitoring of Liquid Effluent Discharges to the Environment	X					Disposal of liquid effluents is not within the W-211 work scope
3.3.6.3.6	Radiation Protection of the Public and Environment			X	2.4.1 & 3.4	Mixer Pumps (Safety Interlocks)	"Safety" interlocks are required for public and environmental protection.
3.3.6.3.6	Radiation Protection of the Public and Environment			X	3.1.	Instrumentation & Control (Safe Operation & Failure)	Airborne emissions must be limited during operation and system failures.
3.3.6.3.6	Radiation Protection of the Public and Environment			X	5.1.5.5	Control of Public Radiation Exposure (Public)	Hanford procedures cited in the specification implement the requirements of HSCRM-1 which is cited by the FDC.
3.3.6.3.6	Radiation Protection of the Public and Environment			X	5.2.	Environmental Protection	The system must contain waste during design basis events.
3.3.6.3.6	Radiation Protection of the Public and Environment			X	5.2.	Environmental Protection	The system must contain waste during design basis events.
3.3.6.3.6	Radiation Protection of the Public and Environment			X	6.2	U.S. Code of Federal Regulations (Radiation Protection)	Hanford procedures cited in the specification implement the requirements of the DOE Order cited by the FDC.
3.3.6.3.6	Radiation Protection of the Public and Environment			X	6.3	U. S. Department of Energy Orders (Radiation Protection)	Hanford procedures cited in the specification implement the requirements of the DOE Order cited by the FDC.
3.3.6.3.7	Flammable Gas (LFL & UFL)/Gas & Steam Bumps/Containment Vessel Pressure			X	3.1.	Instrumentation & Control (Safe Operation & Failure)	Flammable gas concentrations must be controlled during normal and off-normal operations.
3.3.6.3.7	Flammable Gas (LFL & UFL)/Gas & Steam Bumps/Containment Vessel Pressure			X	5.1.	Safety (Flammable Gas)	Both require control of flammable gas concentrations.

## BASELINE COMPARISON OF DST SYSTEM SPECIFICATION TO W-211 FUNCTIONAL DESIGN CRITERIA

Based on DST System Specification: HNF-SD-WM-TRD-007, Rev. D, April, 1998 and W-211 Functional Design Criteria: HNF-SD-W211-FDC-001, Rev 3-A

PARA. NUMBER	DST SYSTEM SPEC. REQUIREMENT	COMPARABLE/DERIVABLE REQUIREMENT			SECTION #	W-211 FDC REQUIREMENT	Notes
		N/A	No	Yes			
3.3.7	Human Engineering			X	3.1.	Instrumentation & Control (Human Eng.)	Section 5.5 invokes DOE Order 6430.1A.
3.3.7	Human Engineering			X	5.5.	Human Factors	Both invoke DOE Order 6430.1A.
3.3.8	Nuclear Safety						
3.3.8.1	Criticality Safety			X	2.4.4	Services (Electrical)	FDC identifies need for safety analysis to determine the reliability and availability necessary for nuclear safety. This will determine the need for standby and/or uninterruptible power.
3.3.8.1	Criticality Safety			X	3.1.	Instrumentation & Control (Safe Operation & Failure)	The system must avoid a criticality during design basis events.
3.3.8.1	Criticality Safety			X	5.1.1	Criticality Safety	Both invoke DOE Order 6430.1A.
3.3.8.2	Nuclear Safety			X	5.1 & 5.1.2	Safety Analysis	Both require safety analysis
3.3.8.2	Nuclear Safety			X	5.1.2.1	Design Basis Accidents (Loads)	Both require safety analysis using design basis accidents.
3.3.8.2	Nuclear Safety			X	6.3	U. S. Department of Energy Orders (Nuclear Safety)	Both require a safety analysis.
3.3.8.2	Nuclear Safety Classification			X	2.4.1 & 3.4	Mixer Pumps (Safety Interlocks)	"Safety" interlocks are required for nuclear safety.
3.3.8.2	Nuclear Safety Classification			X	5.4.6	Design Basis Fire	Analysis of radiological consequences of a fire would be included in the safety analysis.
3.3.9	System Security						
3.3.9.1	General System and Information Security			X	5.3.	Safeguards and Security	FDC uses RLID 5632.1B, "Asset Protection Requirements." The specification uses HNF-PRO-394 which references the implementing DOE manual (DOE M 5632.1C-1).
3.3.9.2	Radiation Area Security			X	5.5	Site Standards	Both invoke HSRCM-1.
3.3.10	Government Furnished Property Usage	X					No GFE will be provided to W-211 project.
3.4	DOCUMENTATION			X	5.6.	Design Format (Drawings)	FDC addresses requirements for drawing only. Specification also addresses requirements for controlled documents and QA records. W-211 has a separate agreement to maintain QA records and to use controlled documents.
3.5	LOGISTICS						
3.5.1	Maintenance and Operation			X	2.4.1	Mixer Pumps (Monitoring)	It is assumed that this instrumentation would be used for predictive maintenance to provide sufficient reliability and availability to meet mission needs
3.5.1	Maintenance and Operation			X	2.4.3	Other Operating Rqmnts (Remote Operation)	Both require remote operation.
3.5.1	Maintenance and Operation			X	3.1	Instrumentation & Control (Operation)	Specification requires remote operation (e.g., monitoring). FDC requires stations for monitoring operation.
3.5.1	Maintenance and Operation			X	4.6.2	Maintenance Equipment (Concept)	DST specification requires the ability to perform maintenance. FDC requires ability to remove equipment intact.
3.5.1.1	Calibration		X		3.1	Instrumentation & Control (Maintenance)	FDC doesn't contain calibration requirements.
3.5.2	Transportation of Hazardous Materials			X	2.4.6	Shipping & Handling (Hazardous Material Shipping)	FDC uses WHC-CM-2-14 which has been replaced by HNF-PRO-157 which is used in the system specification
3.5.3	Solid Waste						
3.5.3.1	Solid Waste Acceptance Criteria	X					Requirement is beyond scope of W-211 project.
3.6	Personnel and Training	X					Function is beyond scope of W-211 project. The project, however, will pay for initial operator training on equipment provided by W-211.
4.0	QUALITY ASSURANCE PROVISIONS			X	5.7 & 6.2	U.S. Code of Federal Regulations (QA)	Both reference DOE Order 6430.1A.