



DEFENSE NUCLEAR FACILITIES SAFETY BOARD

Fiscal Year 2020 President's Budget Request and Agency Overview

Presented to

Congressional Committees

April 2019



- **Board Overview**
- Board Activities
- NAPA and Agency Reform
- Budget Summary
- Board Member Personal Remarks



Board Overview

- “The mission of the Board shall be to provide independent analysis, advice, and recommendations to the Secretary of Energy to inform the Secretary, in the role of the Secretary as operator and regulator of the defense nuclear facilities of the Department of Energy, in providing adequate protection of public health and safety at defense nuclear facilities.”

Current Board Members



Vice Chairman
Vacant



Board Member
Jessie Hill Roberson



Board Member
Joyce Connery



Board Member
Vacant

- Nominations/Renominations before the Senate:
 - Jessie Hill Roberson, term through 2023
 - Bruce Hamilton, term through 2022
 - Lisa Vickers, term through 2021
 - Thomas Summers, term through 2020



- Board Overview
- **Board Activities**
- NAPA and Agency Reform
- Budget Summary
- Board Member Personal Remarks



FY 2019 Hearings and Meetings

- February 21, 2019, Albuquerque, NM [Third Public Hearing on DOE Order 140.1]
- February 14, 2019, Washington, DC [Public Business Meeting on NAPA recommendations]
- January 16, 2019, Washington, DC [Public Business Meeting on NAPA recommendations]
- December 20, 2018, Washington, DC [Public Business Meeting on NAPA recommendations]
- November 28, 2018, Washington, DC [Second Public Hearing on DOE Order 140.1]
- Closed Meetings
 - March 19, 2019, Washington, DC
 - February 26, 2019, Washington, DC
 - February 7, 2019, Washington, DC
 - December 12, 2018, Washington, DC
 - November 5, 2018, Washington, DC
 - October 23, 2018, Washington, DC



Open Recommendations

- Recommendation 2011-1, *Safety Culture at the Waste Treatment and Immobilization Plant*
 - Staff evaluating DOE actions against the original Recommendation to ascertain if original concerns are resolved.
- Recommendation 2012-1, *Savannah River Site Building 235-F Safety*
 - Mitigation of Pu-238 hazard in progress, currently focused on Cell 1
- Recommendation 2012-2, *Hanford Tank Farms Flammable Gas Safety Strategy*
 - DOE working to implement tank ventilation that meets requirements for safety-related systems; near term deliverables delayed one year
- Recommendation 2019-1, *Pantex Uncontrolled Hazard Scenarios and 10 CFR 830 Implementation*
 - DOE response pending



Pantex Plant: Recommendation 2019-1

High Explosive Violent Reaction and/or Inadvertent Nuclear Detonation

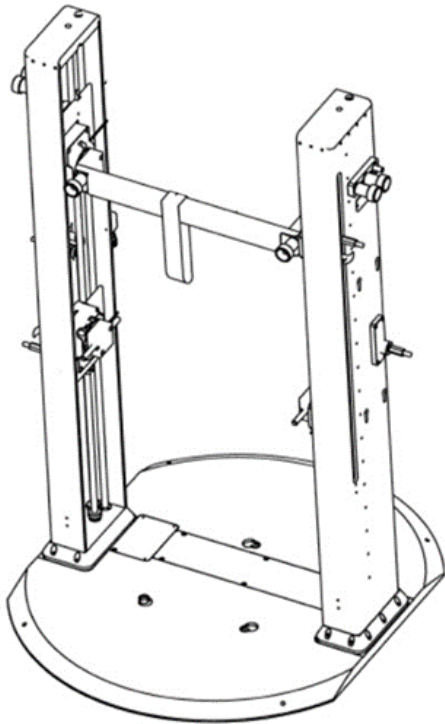

- Implement compensatory measures to address the deficiencies the Board identified at Pantex.
- Perform an extent-of-condition evaluation of the Pantex safety basis and take action to ensure it complies with DOE regulations and directives.
- Ensure process design and engineering controls such as special tooling address impact and falling technician scenarios for nuclear explosives.
- Ensure design, procurement, manufacturing, and maintenance of special tooling is commensurate with its safety function.
- Train safety basis personnel to ensure future revisions to the safety basis comply with 10 CFR 830 requirements.



Los Alamos National Laboratory

- Plutonium Facility (PF-4)
 - Deficiencies in facility safety basis and safety systems
 - Deficiencies in nuclear criticality safety program
- Transuranic Waste Management
 - Safety basis for Area G transuranic waste operations
 - Safety controls for mobile loading of transuranic waste for shipment to Waste Isolation Pilot Plant



Los Alamos Area G Mobile Loading Activities



Idaho National Laboratory Drum Event

- Board analyzing implications of April 2018 solid waste drum over-pressurization event in Accelerated Retrieval Project (ARP) V
- Public hearing on complex-wide waste management planned for May 2019
- Near-term challenges:
 - Assuring chemical compatibility of wastes being processed
 - Controls at the generator sites
 - Controls to protect WIPP
 - Hazards proposed by generation of flammable gases (e.g., methane)





Waste Isolation Pilot Plant Operations

- Board reviewing revised safety basis and safety management programs related to maintenance, radiological protection, and ground control
- Near-term challenges:
 - Deconflicting Ground Control & Emplacement
 - Upgrading ventilation capabilities
 - Sustaining safe operations
 - Implementing the new Waste Acceptance Criteria across the complex





Hanford: Decommissioning and Demolition of Legacy Facilities and Retrieval of High-Level Waste

- Clean-up work poses worker hazards and potential for radioactive releases
 - Recent spread of contamination at PFP
 - Managing high-level waste among aging tank farms while awaiting vitrification poses engineering and operational challenges
 - Grouting of Tunnel 2 at PUREX
- Board is monitoring DOE efforts to demolish deactivated high hazard plutonium production and processing facilities, and to retrieve and disposition nuclear waste that was created during the production of plutonium
- DOE planning retrieval of contaminated soil from below Building 324 to support eventual demolition of Building 324



Hanford Tank Farm Workers



Savannah River Site: Multiple Activities and Interests

- Tritium Facilities
 - Design basis accidents with onsite consequences
 - Revised safety basis under development
- Processing & storage of nuclear materials
 - Plutonium storage and down-blend
 - Spent nuclear fuel storage and processing
 - High-level waste storage and processing
- Start up of Salt Waste Processing Facility
- Aging facilities and infrastructure
 - H-Canyon exhaust tunnel degradation
 - 3H high-level waste evaporator repair
 - SRNL fire water tank replacement



Crawler Inspection of SRS H-Canyon Exhaust Tunnel



Y-12 National Security Complex and ORNL

- Y-12
 - Nuclear criticality safety program
 - Uranium accumulation in process equipment
 - Materials not evaluated for storage in Highly Enriched Uranium Materials Facility
 - Construction of Uranium Processing Facility

- ORNL
 - Downblending of U-233 oxide powders, metals, monoliths, and salts for disposal at NNSS
 - Oxidation of fissile metals at Transuranic Waste Processing Center



Y-12 Building 9212





Nevada National Nuclear Security Site

- Device Assembly Facility / National Criticality Experiments Research Center
 - Fire suppression system upgrades
 - Seismic / structural analysis update
 - Revised documented safety analysis to remove nuclear explosive operations
- U1a Complex
 - Reliance on administrative safety controls for subcritical experiments
 - Evaluation of leak from containment vessel during latest experiment

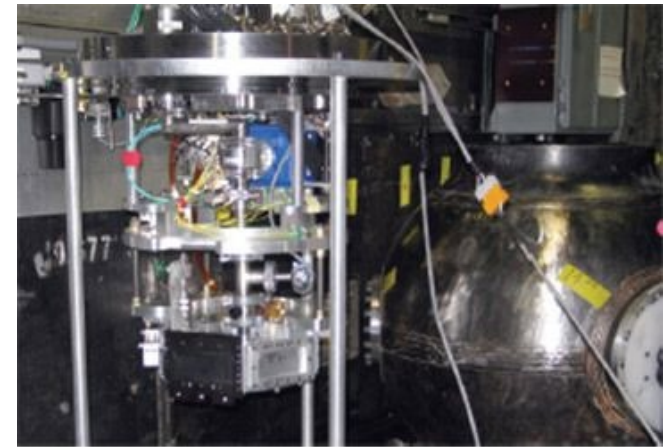
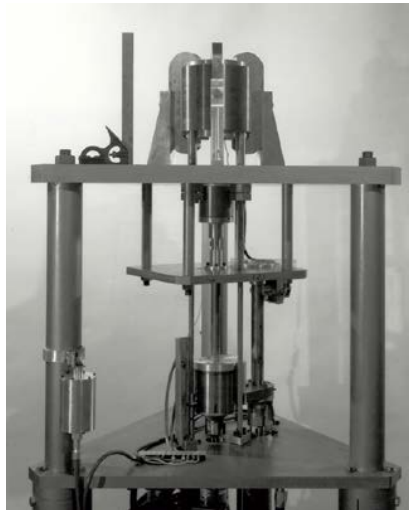

Flat-Top and Godiva IV Critical Assemblies



Lawrence Livermore and Sandia National Laboratories

- LLNL TRU waste characterization
 - Approximately 900 TRU waste containers
 - Characterization to verify compliance with WIPP waste acceptance criteria
 - Shipment to WIPP expected to begin in early FY 2020
- SNL TRU waste repackaging
 - Waste with a mixture of $\text{UO}_2/\text{Gd}_2\text{O}_3$ in water
 - Repackaging into shielded containers in the Auxiliary Hot Cell Facility
 - Shipment to WIPP expected in early FY 2020



TRU Waste at LLNL



SNL Auxiliary Hot Cell Facility



Aging Infrastructure

- Aging facilities are prone to:
 - Degraded systems and structures
 - Increased radiological hold-up
 - Obsolescent equipment and unavailable replacement parts
 - Retrofits to meet evolving missions
- Use of Administrative Controls coupled with inexperienced staff presents challenges
- Board monitoring DOE efforts to mitigate risks and develop replacement capabilities; for example:
 - Y-12 Extended Life Program
 - LANL Plutonium Strategy
 - Pantex ramps structural retrofits and safety system upgrades



Los Alamos Chemistry, Metallurgy, and Research (CMR) Facility



Design and Construction

- Focus of Board reviews
 - Before construction: Safety basis and safety-related structures, systems, & components
 - During construction: Quality assurance and operability testing of safety systems
- More than a dozen new facilities under Board purview
 - Hanford Waste Treatment and Immobilization Plant and related facilities
 - Y-12 Uranium Processing Facility (UPF)
 - Savannah River Salt Waste Processing Facility
 - Pantex Material Staging Facility



Hanford Waste Treatment and Immobilization Plant



Savannah River Site Salt Waste Processing Facility



Safety Management Programs

- DOE increasingly relies on administrative controls rather than engineered controls to ensure adequate protection of public health & safety
- Examples of Board reviews focused on administrative controls and safety programs:
 - Review of 10 CFR 830, *Nuclear Safety Management*
 - 8/18/18—DOE published proposed revision to Nuclear Safety Materials (10 CFR Part 830)
 - 10/5/18—Board submitted detailed comments to Secretary of Energy
 - Review of uranium airborne release and respirable fractions used in DOE Handbook 3010-94, *Airborne Release Fractions/Rates and Respirable Fractions for Nonreactor Nuclear Facilities*
 - Pantex Safety Inquiry regarding 10 CFR 830
 - Emergency Preparedness and Response
 - Verification and validation of DOE response to Recommendation 15-1, *Emergency Preparedness and Response at the Pantex Plant*
 - Criticality Safety
 - Programmatic review at LANL
 - Programmatic review at Y-12





DOE Order 140.1

- DOE Order 140.1 is inconsistent with the Atomic Energy Act, as amended, in four primary ways:
 - Limits DNFSB to facilities where *DOE determines* adequate protection may be affected.
 - Defines “Public Health and Safety” as outside the site boundary only.
 - Exempts the Board’s access from Category 3 and below facilities (80% exempted).
 - Limits the Board’s access to deliberative or pre-decisional information. The Atomic Energy Act gives *the Board* the authority to determine the information needed for the Board to perform its mission.



- Board Overview
- Board Activities
- **NAPA and Agency Reform**
- Budget Summary
- Board Member Personal Remarks



National Academy of Public Administration (NAPA)

- Board contracted with National Academy of Public Administration (NAPA) to perform organizational assessment
- NAPA report was issued on November 13, 2018
- NAPA had 16 recommendations
- Board is deliberating about specific actions proposed in the NAPA recommendations in Public Business Meetings

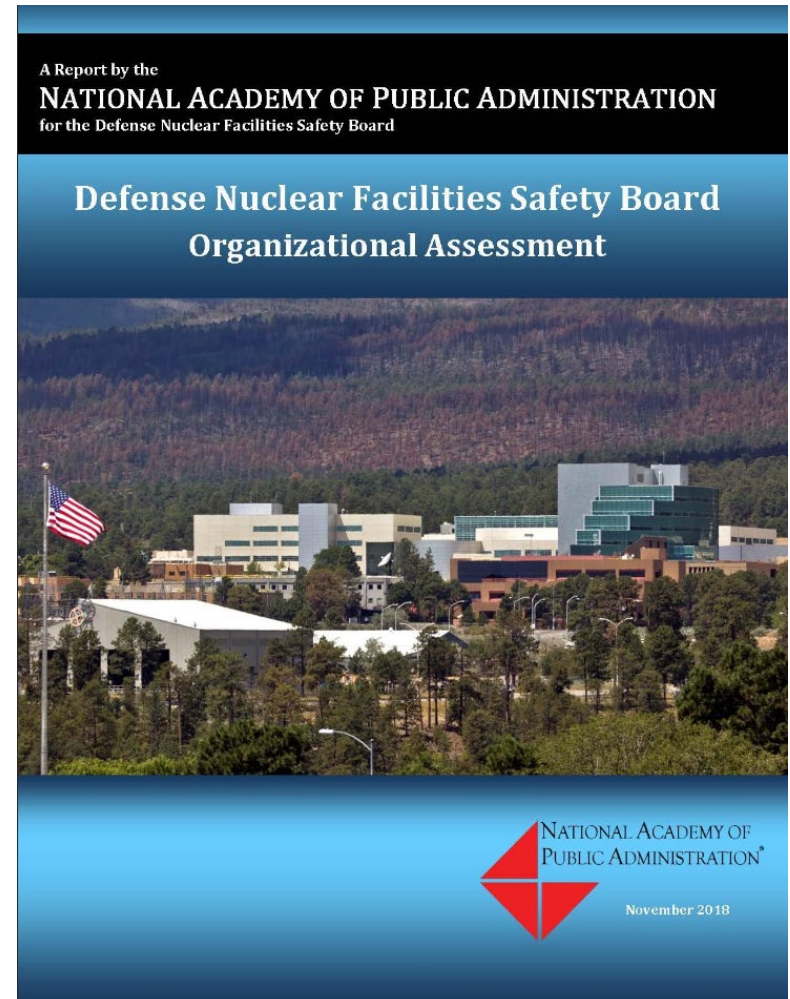



Agency Reform Plan

- August 14, 2018 – The Board approved an Agency Reform plan
 - Establish an Executive Director of Operations (EDO)
 - Assign staff as Resident Inspectors to cover LLNL, INL, NNSS, SNL, and WIPP
 - In FY 2019, establish a limit of 100 FTE¹ (86 employees, 5 Board Members, and 9 SES)
 - In FY 2020, further attrition to 79 FTE (69 employees, 5 Board Members, and 5 SES)
- FY 2019 Appropriation Bill (H.R. 5895) states:
 - “For expenses necessary for the Defense Nuclear Facilities Safety Board in carrying out activities authorized by the Atomic Energy Act of 1954, ... Provided, That none of the funds made available by this or any prior Act for the salaries and expenses of the Defense Nuclear Facilities Safety Board shall be available to implement any reform and reorganization plan of the Defense Nuclear Facilities Safety Board, including the plan announced on August 15, 2018, unless any such reform and reorganization plan is specifically authorized by law.”

¹ On August 14, 2018, DNFSB had 94 employees on-board



- Board Overview
- Board Activities
- NAPA and Agency Reform
- **Budget Summary**
- Board Member Personal Remarks



Budget Summary

	FY 2018 <u>Actual</u>	FY 2019 <u>Plan</u>	FY 2020 <u>Request</u> ²
Budget Authority (in millions)	\$31.0 ³	\$31.0	\$29.5
Obligations (in millions)	\$29.8	\$32.3	\$32.3
Outlays (in millions)	\$29.0	\$30.3	\$30.4
FTE Usage	102	102	100
Total On-Board Employees April 2019	89	86	-
Total On-Board Employees Projected at end of FY	89	102	100

² On March 18, 2019, a motion before the Board to approve the FY 2020 Congressional Budget Request failed due to lack of quorum.

³ The Appropriations Act Conference Report language includes funding of \$400,000 “above the request to support activities for employee engagement.” These funds will be used for, among other things, employee development, training, mentoring, coaching, and employee engagement-related contractual services (potentially with the National Academy of Public Administration).



FY 2020 TOTAL PROJECTED OBLIGATIONS = \$32,302,100

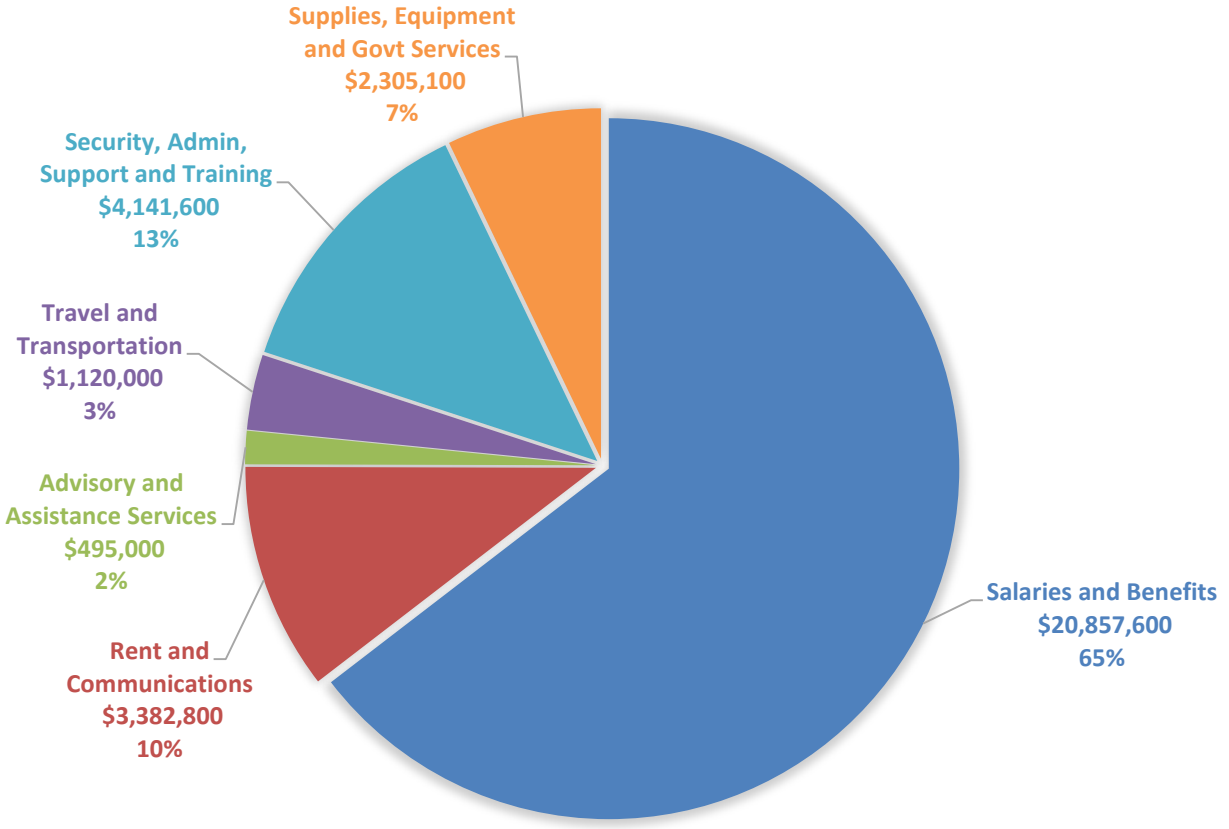



- Board Overview
- Board Activities
- NAPA and Agency Reform
- Budget Summary
- **Board Member Personal Remarks**

AFFIRMATION OF BOARD VOTING RECORD

SUBJECT: FY20 Budget Slides

Doc Control#: 2019-100-0023

The Board acted on the above document on 04/17/2019. The document was Approved.

The votes were recorded as:

	APRVD	DISAPRVD	ABSTAIN	NOT PARTICIPATING	COMMENT	DATE
Bruce Hamilton	<input checked="" type="checkbox"/>	<input type="checkbox"/>	<input type="checkbox"/>	<input type="checkbox"/>	<input type="checkbox"/>	04/17/2019
Jessie H. Roberson	<input checked="" type="checkbox"/>	<input type="checkbox"/>	<input type="checkbox"/>	<input type="checkbox"/>	<input checked="" type="checkbox"/>	04/17/2019
Joyce L. Connery	<input checked="" type="checkbox"/>	<input type="checkbox"/>	<input type="checkbox"/>	<input type="checkbox"/>	<input type="checkbox"/>	04/17/2019

This Record contains a summary of voting on this matter together with the individual vote sheets, views and comments of the Board Members.

Shelby Qualls

Executive Secretary to the Board

Attachments:

1. Voting Summary
2. Board Member Vote Sheets

DEFENSE NUCLEAR FACILITIES SAFETY BOARD
NOTATIONAL VOTE RESPONSE SHEET

FROM: Bruce Hamilton

SUBJECT: FY20 Budget Slides

Doc Control#: 2019-100-0023

DATE: 04/17/2019

VOTE: Approved

COMMENTS:

None

Bruce Hamilton

DEFENSE NUCLEAR FACILITIES SAFETY BOARD
NOTATIONAL VOTE RESPONSE SHEET

FROM: **Jessie Roberson**

SUBJECT: **FY20 Budget Slides**

Doc Control#2019-100-023

Approved X **Disapproved** **Abstain**

Recusal – Not Participating

COMMENTS: **Below** X **Attached** **None**

While the footnote on page 24 accurately reflects that the proposal to the Board to approve the President’s FY 2020 Congressional Request failed due to lack of a quorum it leaves silent that the Board also did not approve (by vote) submission of the same agency budget request to OMB on October 17, 2018.

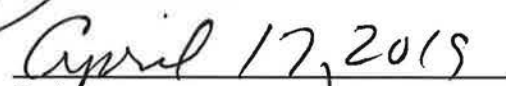

Jessie Roberson

Date

DEFENSE NUCLEAR FACILITIES SAFETY BOARD
NOTATIONAL VOTE RESPONSE SHEET

FROM: Joyce L. Connery

SUBJECT: FY20 Budget Slides

Doc Control#: 2019-100-0023

DATE: 04/17/2019

VOTE: Approved

COMMENTS:

None

Joyce L. Connery